

Cutting Tools

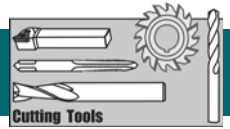

JOBBERS DRILLS

High Speed Steel, 118° Point

Fractional Sizes



Size	Flute Length	Overall Length	Rolled Black Oxide Model No.	Rolled Polished Model No.	Milled Black Oxide Model No.	Milled Polished Model No.	Ground Black Oxide Model No.	Ground Bright Model No.	Ground Tin-Coated Model No.
1/64	3/16	3/4	234-4001	234-6001	434-4001	434-6001	334-4001	334-3001	334-5001
1/32	1/2	1-3/8	234-4002	234-6002	434-4002	434-6002	334-4002	334-3002	334-5002
3/64	3/4	1-3/4	234-4003	234-6003	434-4003	434-6003	334-4003	334-3003	334-5003
1/16	7/8	1-7/8	234-4004	234-6004	434-4004	434-6004	334-4004	334-3004	334-5004
5/64	1 "	2 "	234-4005	234-6005	434-4005	434-6005	334-4005	334-3005	334-5005
3/32	1-1/4	2-1/4	234-4006	234-6006	434-4006	434-6006	334-4006	334-3006	334-5006
7/64	1-1/2	2-5/8	234-4007	234-6007	434-4007	434-6007	334-4007	334-3007	334-5007
1/8	1-5/8	2-3/4	234-4008	234-6008	434-4008	434-6008	334-4008	334-3008	334-5008
9/64	1-3/4	2-7/8	234-4009	234-6009	434-4009	434-6009	334-4009	334-3009	334-5009
5/32	2 "	3-1/8	234-4010	234-6010	434-4010	434-6010	334-4010	334-3010	334-5010
11/64	2-1/8	3-1/4	234-4011	234-6011	434-4011	434-6011	334-4011	334-3011	334-5011
3/16	2-5/16	3-1/2	234-4012	234-6012	434-4012	434-6012	334-4012	334-3012	334-5012
13/64	2-7/16	3-5/8	234-4013	234-6013	434-4013	434-6013	334-4013	334-3013	334-5013
7/32	2-1/2	3-3/4	234-4014	234-6014	434-4014	434-6014	334-4014	334-3014	334-5014
15/64	2-5/8	3-7/8	234-4015	234-6015	434-4015	434-6015	334-4015	334-3015	334-5015
1/4	2-3/4	4 "	234-4016	234-6016	434-4016	434-6016	334-4016	334-3016	334-5016
17/64	2-7/8	4-1/8	234-4017	234-6017	434-4017	434-6017	334-4017	334-3017	334-5017
9/32	2-5/16	4-1/4	234-4018	234-6018	434-4018	434-6018	334-4018	334-3018	334-5018
19/64	3-1/16	4-3/8	234-4019	234-6019	434-4019	434-6019	334-4019	334-3019	334-5019
5/16	3-3/16	4-1/2	234-4020	234-6020	434-4020	434-6020	334-4020	334-3020	334-5020
21/64	3-5/16	4-5/8	234-4021	234-6021	434-4021	434-6021	334-4021	334-3021	334-5021
11/32	3-7/16	4-3/4	234-4022	234-6022	434-4022	434-6022	334-4022	334-3022	334-5022
23/64	3-1/2	4-7/8	234-4023	234-6023	434-4023	434-6023	334-4023	334-3023	334-5023
3/8	3-5/8	5 "	234-4024	234-6024	434-4024	434-6024	334-4024	334-3024	334-5024
25/64	3-3/4	5-1/8	234-4025	234-6025	434-4025	434-6025	334-4025	334-3025	334-5025
13/32	3-7/8	5-1/4	234-4026	234-6026	434-4026	434-6026	334-4026	334-3026	334-5026
27/64	3-5/16	5-3/8	234-4027	234-6027	434-4027	434-6027	334-4027	334-3027	334-5027
7/16	4-1/16	5-1/2	234-4028	234-6028	434-4028	434-6028	334-4028	334-3028	334-5028
29/64	4-3/16	5-5/8	234-4029	234-6029	434-4029	434-6029	334-4029	334-3029	334-5029
15/32	4-5/16	5-3/4	234-4030	234-6030	434-4030	434-6030	334-4030	334-3030	334-5030
31/64	4-3/8	5-7/8	234-4031	234-6031	434-4031	434-6031	334-4031	334-3031	334-5031
1/2	4-1/2	6 "	234-4032	234-6032	434-4032	434-6032	334-4032	334-3032	334-5032
33/64	4-3/16	6-5/8	234-4033	234-6033	434-4033	434-6033	334-4033	334-3033	334-5033
17/32	4-3/16	6-5/8	234-4034	234-6034	434-4034	434-6034	334-4034	334-3034	334-5034
35/64	4-3/16	6-5/8	234-4035	234-6035	434-4035	434-6035	334-4035	334-3035	334-5035
9/16	4-3/16	6-5/8	234-4036	234-6036	434-4036	434-6036	334-4036	334-3036	334-5036
37/64	4-3/16	6-5/8	234-4037	234-6037	434-4037	434-6037	334-4037	334-3037	334-5037
19/32	5-3/16	7-1/8	234-4038	234-6038	434-4038	434-6038	334-4038	334-3038	334-5038
39/64	5-3/16	7-1/8	234-4039	234-6039	434-4039	434-6039	334-4039	334-3039	334-5039
5/8	5-3/16	7-1/8	234-4040	234-6040	434-4040	434-6040	334-4040	334-3040	334-5040
41/64	5-3/16	7-1/8	234-4041	234-6041	434-4041	434-6041	334-4041	334-3041	334-5041
21/32	5-3/16	7-1/8	234-4042	234-6042	434-4042	434-6042	334-4042	334-3042	334-5042
43/64	5-5/8	7-5/8	234-4043	234-6043	434-4043	434-6043	334-4043	334-3043	334-5043
11/16	5-5/8	7-5/8	234-4044	234-6044	434-4044	434-6044	334-4044	334-3044	334-5044
3/4		7-5/8	234-4048	234-6048	434-4048	434-6048	334-4048	334-3048	334-5048
25/32		8-1/8	234-4050	234-6050	434-4050	434-6050	334-4050	334-3050	334-5050

Letter Sizes

Size	Overall Length	Rolled Black Oxide Model No.	Rolled Polished Model No.	Milled Black Oxide Model No.	Milled Polished Model No.	Ground Black Oxide Model No.	Ground Bright Model No.	Ground Tin-Coated Model No.
A	3-7/8	234-4201	234-6201	434-4201	434-6201	334-4201	334-3201	334-5201
B	4 "	234-4202	234-6202	434-4202	434-6202	334-4202	334-3202	334-5202
C	4 "	234-4203	234-6203	434-4203	434-6203	334-4203	334-3203	334-5203
D	4 "	234-4204	234-6204	434-4204	434-6204	334-4204	334-3204	334-5204
E	4 "	234-4205	234-6205	434-4205	434-6205	334-4205	334-3205	334-5205
F	4-1/8	234-4206	234-6206	434-4206	434-6206	334-4206	334-3206	334-5206
G	4-1/8	234-4207	234-6207	434-4207	434-6207	334-4207	334-3207	334-5207
H	4-1/8	234-4208	234-6208	434-4208	434-6208	334-4208	334-3208	334-5208
I	4-1/8	234-4209	234-6209	434-4209	434-6209	334-4209	334-3209	334-5209
J	4-1/8	234-4210	234-6210	434-4210	434-6210	334-4210	334-3210	334-5210
K	4-1/4	234-4211	234-6211	434-4211	434-6211	334-4211	334-3211	334-5211
L	4-1/4	234-4212	234-6212	434-4212	434-6212	334-4212	334-3212	334-5212
M	4-3/8	234-4213	234-6213	434-4213	434-6213	334-4213	334-3213	334-5213
N	4-3/8	234-4214	234-6214	434-4214	434-6214	334-4214	334-3214	334-5214
O	4-1/2	234-4215	234-6215	434-4215	434-6215	334-4215	334-3215	334-5215
P	4-5/8	234-4216	234-6216	434-4216	434-6216	334-4216	334-3216	334-5216
Q	4-3/4	234-4217	234-6217	434-4217	434-6217	334-4217	334-3217	334-5217
R	4-3/4	234-4218	234-6218	434-4218	434-6218	334-4218	334-3218	334-5218
S	4-7/8	234-4219	234-6219	434-4219	434-6219	334-4219	334-3219	334-5219
T	4-7/8	234-4220	234-6220	434-4220	434-6220	334-4220	334-3220	334-5220
U	5 "	234-4221	234-6221	434-4221	434-6221	334-4221	334-3221	334-5221
V	5 "	234-4222	234-6222	434-4222	434-6222	334-4222	334-3222	334-5222
W	5-1/8	234-4223	234-6223	434-4223	434-6223	334-4223	334-3223	334-5223
X	5-1/8	234-4224	234-6224	434-4224	434-6224	334-4224	334-3224	334-5224
Y	5-1/4	234-4225	234-6225	434-4225	434-6225	334-4225	334-3225	334-5225
Z	5-1/4	234-4226	234-6226	434-4226	434-6226	334-4226	334-3226	334-5226



Cutting Tools

JOBBERS DRILLS continued

Number Sizes



Size	Flute Length	Overall Length	Rolled Black Oxide Model No.	Rolled Polished Model No.	Milled Black Oxide Model No.	Milled Polished Model No.	Ground Black Oxide Model No.	Ground Bright Model No.	Ground Tin-Coated Model No.
1	2-5/8	3-7/8	234-4101	234-6101	434-4101	434-6101	334-4101	334-3101	334-5101
2	2-5/8	3-7/8	234-4102	234-6102	434-4102	434-6102	334-4102	334-3102	334-5102
3	2-1/2	3-3/4	234-4103	234-6103	434-4103	434-6103	334-4103	334-3103	334-5103
4	2-1/2	3-3/4	234-4104	234-6104	434-4104	434-6104	334-4104	334-3104	334-5104
5	2-1/2	3-3/4	234-4105	234-6105	434-4105	434-6105	334-4105	334-3105	334-5105
6	2-1/2	3-3/4	234-4106	234-6106	434-4106	434-6106	334-4106	334-3106	334-5106
7	2-7/16	3-5/8	234-4107	234-6107	434-4107	434-6107	334-4107	334-3107	334-5107
8	2-7/16	3-5/8	234-4108	234-6108	434-4108	434-6108	334-4108	334-3108	334-5108
9	2-7/16	3-5/8	234-4109	234-6109	434-4109	434-6109	334-4109	334-3109	334-5109
10	2-7/16	3-5/8	234-4110	234-6110	434-4110	434-6110	334-4110	334-3110	334-5110
11	2-5/16	3-1/2	234-4111	234-6111	434-4111	434-6111	334-4111	334-3111	334-5111
12	2-5/16	3-1/2	234-4112	234-6112	434-4112	434-6112	334-4112	334-3112	334-5112
13	2-5/16	3-1/2	234-4113	234-6113	434-4113	434-6113	334-4113	334-3113	334-5113
14	2-3/16	3-3/8	234-4114	234-6114	434-4114	434-6114	334-4114	334-3114	334-5114
15	2-3/16	3-3/8	234-4115	234-6115	434-4115	434-6115	334-4115	334-3115	334-5115
16	2-3/16	3-3/8	234-4116	234-6116	434-4116	434-6116	334-4116	334-3116	334-5116
17	2-3/16	3-3/8	234-4117	234-6117	434-4117	434-6117	334-4117	334-3117	334-5117
18	2-1/8	3-1/4	234-4118	234-6118	434-4118	434-6118	334-4118	334-3118	334-5118
19	2-1/8	3-1/4	234-4119	234-6119	434-4119	434-6119	334-4119	334-3119	334-5119
20	2-1/8	3-1/4	234-4120	234-6120	434-4120	434-6120	334-4120	334-3120	334-5120
21	2-1/8	3-1/4	234-4121	234-6121	434-4121	434-6121	334-4121	334-3121	334-5121
22	2"	3-1/8	234-4122	234-6122	434-4122	434-6122	334-4122	334-3122	334-5122
23	2"	3-1/8	234-4123	234-6123	434-4123	434-6123	334-4123	334-3123	334-5123
24	2"	3-1/8	234-4124	234-6124	434-4124	434-6124	334-4124	334-3124	334-5124
25	1-7/8	3"	234-4125	234-6125	434-4125	434-6125	334-4125	334-3125	334-5125
26	1-7/8	3"	234-4126	234-6126	434-4126	434-6126	334-4126	334-3126	334-5126
27	1-7/8	3"	234-4127	234-6127	434-4127	434-6127	334-4127	334-3127	334-5127
28	1-3/4	2-7/8	234-4128	234-6128	434-4128	434-6128	334-4128	334-3128	334-5128
29	1-3/4	2-7/8	234-4129	234-6129	434-4129	434-6129	334-4129	334-3129	334-5129
30	1-5/8	2-3/4	234-4130	234-6130	434-4130	434-6130	334-4130	334-3130	334-5130
31	1-5/8	2-3/4	234-4131	234-6131	434-4131	434-6131	334-4131	334-3131	334-5131
32	1-5/8	2-3/4	234-4132	234-6132	434-4132	434-6132	334-4132	334-3132	334-5132
33	1-1/2	2-5/8	234-4133	234-6133	434-4133	434-6133	334-4133	334-3133	334-5133
34	1-1/2	2-5/8	234-4134	234-6134	434-4134	434-6134	334-4134	334-3134	334-5134
35	1-1/2	2-5/8	234-4135	234-6135	434-4135	434-6135	334-4135	334-3135	334-5135
36	1-7/16	2-1/2	234-4136	234-6136	434-4136	434-6136	334-4136	334-3136	334-5136
37	1-7/16	2-1/2	234-4137	234-6137	434-4137	434-6137	334-4137	334-3137	334-5137
38	1-7/16	2-1/2	234-4138	234-6138	434-4138	434-6138	334-4138	334-3138	334-5138
39	1-3/8	2-3/8	234-4139	234-6139	434-4139	434-6139	334-4139	334-3139	334-5139
40	1-3/8	2-3/8	234-4140	234-6140	434-4140	434-6140	334-4140	334-3140	334-5140
41	1-3/8	2-3/8	234-4141	234-6141	434-4141	434-6141	334-4141	334-3141	334-5141
42	1-1/4	2-1/4	234-4142	234-6142	434-4142	434-6142	334-4142	334-3142	334-5142
43	1-1/4	2-1/4	234-4143	234-6143	434-4143	434-6143	334-4143	334-3143	334-5143
44	1-1/8	2-1/4	234-4144	234-6144	434-4144	434-6144	334-4144	334-3144	334-5144
45	1-1/8	2-1/8	234-4145	234-6145	434-4145	434-6145	334-4145	334-3145	334-5145
46	1-1/8	2-1/8	234-4146	234-6146	434-4146	434-6146	334-4146	334-3146	334-5146
47	1"	2"	234-4147	234-6147	434-4147	434-6147	334-4147	334-3147	334-5147
48	1"	2"	234-4148	234-6148	434-4148	434-6148	334-4148	334-3148	334-5148
49	1"	2"	234-4149	234-6149	434-4149	434-6149	334-4149	334-3149	334-5149
50	1"	2"	234-4150	234-6150	434-4150	434-6150	334-4150	334-3150	334-5150
51	1"	2"	234-4151	234-6151	434-4151	434-6151	334-4151	334-3151	334-5151
52	7/8	1-7/8	234-4152	234-6152	434-4152	434-6152	334-4152	334-3152	334-5152
53	7/8	1-7/8	234-4153	234-6153	434-4153	434-6153	334-4153	334-3153	334-5153
54	7/8	1-7/8	234-4154	234-6154	434-4154	434-6154	334-4154	334-3154	334-5154
55	7/8	1-7/8	234-4155	234-6155	434-4155	434-6155	334-4155	334-3155	334-5155
56	3/4	1-3/4	234-4156	234-6156	434-4156	434-6156	334-4156	334-3156	334-5156
57	3/4	1-3/4	234-4157	234-6157	434-4157	434-6157	334-4157	334-3157	334-5157
58	11/16	1-5/8	234-4158	234-6158	434-4158	434-6158	334-4158	334-3158	334-5158
59	11/16	1-5/8	234-4159	234-6159	434-4159	434-6159	334-4159	334-3159	334-5159
60	11/16	1-5/8	234-4160	234-6160	434-4160	434-6160	334-4160	334-3160	334-5160
61	11/16	1-5/8	234-4161	234-6161	434-4161	434-6161	334-4161	334-3161	334-5161
62	5/8	1-1/2	234-4162	234-6162	434-4162	434-6162	334-4162	334-3162	334-5162
63	5/8	1-1/2	234-4163	234-6163	434-4163	434-6163	334-4163	334-3163	334-5163
64	5/8	1-1/2	234-4164	234-6164	434-4164	434-6164	334-4164	334-3164	334-5164
65	5/8	1-1/2	234-4165	234-6165	434-4165	434-6165	334-4165	334-3165	334-5165
66	1/2	1-3/8	234-4166	234-6166	434-4166	434-6166	334-4166	334-3166	334-5166
67	1/2	1-3/8	234-4167	234-6167	434-4167	434-6167	334-4167	334-3167	334-5167
68	1/2	1-3/8	234-4168	234-6168	434-4168	434-6168	334-4168	334-3168	334-5168
69	1/2	1-3/8	234-4169	234-6169	434-4169	434-6169	334-4169	334-3169	334-5169
70	3/8	1-1/4	234-4170	234-6170	434-4170	434-6170	334-4170	334-3170	334-5170
71	3/8	1-1/4	234-4171	234-6171	434-4171	434-6171	334-4171	334-3171	334-5171
72	5/16	1-1/8	234-4172	234-6172	434-4172	434-6172	334-4172	334-3172	334-5172
73	5/16	1-1/8	234-4173	234-6173	434-4173	434-6173	334-4173	334-3173	334-5173
74	1/4	1"	234-4174	234-6174	434-4174	434-6174	334-4174	334-3174	334-5174
75	1/4	1"	234-4175	234-6175	434-4175	434-6175	334-4175	334-3175	334-5175
76	3/16	7/8	234-4176	234-6176	434-4176	434-6176	334-4176	334-3176	334-5176
77	3/16	7/8	234-4177	234-6177	434-4177	434-6177	334-4177	334-3177	334-5177
78	3/16	7/8	234-4178	234-6178	434-4178	434-6178	334-4178	334-3178	334-5178
79	1/8	3/4	234-4179	234-6179	434-4179	434-6179	334-4179	334-3179	334-5179
80	1/8	3/4	234-4180	234-6180	434-4180	434-6180	334-4180	334-3180	334-5180

WWW.PRECOTOOLS.CN

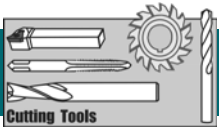

Cutting Tools

SCREW MACHINE DRILLS

High Speed Steel, 118° Point, Right Hand

Fractional Sizes

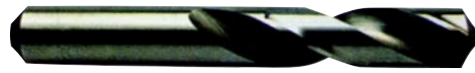

Size	Overall Length	Rolled Black Oxide Model No.	Rolled Polished Model No.	Milled Black Oxide Model No.	Milled Polished Model No.	Ground Black Oxide Model No.	Ground Bright Model No.	Ground Tin-Coated Model No.
3/64	1-9/16	234-0003	234-1003	334-6003	334-7003	334-1003	334-8003	334-2003
1/16	1-5/8	234-0004	234-1004	334-6004	334-7004	334-1004	334-8004	334-2004
5/64	1-11/16	234-0005	234-1005	334-6005	334-7005	334-1005	334-8005	334-2005
3/32	1-3/4	234-0006	234-1006	334-6006	334-7006	334-1006	334-8006	334-2006
7/64	1-13/16	234-0007	234-1007	334-6007	334-7007	334-1007	334-8007	334-2007
1/8	1-7/8	234-0008	234-1008	334-6008	334-7008	334-1008	334-8008	334-2008
9/64	1-15/16	234-0009	234-1009	334-6009	334-7009	334-1009	334-8009	334-2009
5/32	2-1/16	234-0010	234-1010	334-6010	334-7010	334-1010	334-8010	334-2010
11/64	2-1/8	234-0011	234-1011	334-6011	334-7011	334-1011	334-8011	334-2011
3/16	2-3/16	234-0012	234-1012	334-6012	334-7012	334-1012	334-8012	334-2012
13/64	2-1/4	234-0013	234-1013	334-6013	334-7013	334-1013	334-8013	334-2013
7/32	2-3/8	234-0014	234-1014	334-6014	334-7014	334-1014	334-8014	334-2014
15/64	2-7/16	234-0015	234-1015	334-6015	334-7015	334-1015	334-8015	334-2015
1/4	2-1/8	234-0016	234-1016	334-6016	334-7016	334-1016	334-8016	334-2016
17/64	2-5/8	234-0017	234-1017	334-6017	334-7017	334-1017	334-8017	334-2017
9/36	2-11/16	234-0018	234-1018	334-6018	334-7018	334-1018	334-8018	334-2018
19/64	2-3/4	234-0019	234-1019	334-6019	334-7019	334-1019	334-8019	334-2019
5/16	2-13/16	234-0020	234-1020	334-6020	334-7020	334-1020	334-8020	334-2020
21/64	2-15/16	234-0021	234-1021	334-6021	334-7021	334-1021	334-8021	334-2021
11/32	3 "	234-0022	234-1022	334-6022	334-7022	334-1022	334-8022	334-2022
23/64	3-1/16	234-0023	234-1023	334-6023	334-7023	334-1023	334-8023	334-2023
3/8	3-1/8	234-0024	234-1024	334-6024	334-7024	334-1024	334-8024	334-2024
25/64	3-1/4	234-0025	234-1025	334-6025	334-7025	334-1025	334-8025	334-2025
13/32	3-5/16	234-0026	234-1026	334-6026	334-7026	334-1026	334-8026	334-2026
27/64	3-3/8	234-0027	234-1027	334-6027	334-7027	334-1027	334-8027	334-2027
7/16	3-7/16	234-0028	234-1028	334-6028	334-7028	334-1028	334-8028	334-2028
29/64	3-9/16	234-0029	234-1029	334-6029	334-7029	334-1029	334-8029	334-2029
15/32	3-5/8	234-0030	234-1030	334-6030	334-7030	334-1030	334-8030	334-2030
31/64	3-11/16	234-0031	234-1031	334-6031	334-7031	334-1031	334-8031	334-2031
1/2	3-3/4	234-0032	234-1032	334-6032	334-7032	334-1032	334-8032	334-2032
33/64	3-7/8	234-0033	234-1033	334-6033	334-7033	334-1033	334-8033	334-2033
17/32	3-7/8	234-0034	234-1034	334-6034	334-7034	334-1034	334-8034	334-2034
35/64	4 "	234-0035	234-1035	334-6035	334-7035	334-1035	334-8035	334-2035
9/16	4 "	234-0036	234-1036	334-6036	334-7036	334-1036	334-8036	334-2036
37/64	4-1/8	234-0037	234-1037	334-6037	334-7037	334-1037	334-8037	334-2037
19/32	4-1/8	234-0038	234-1038	334-6038	334-7038	334-1038	334-8038	334-2038
39/64	4-1/4	234-0039	234-1039	334-6039	334-7039	334-1039	334-8039	334-2039
5/8	4-1/4	234-0040	234-1040	334-6040	334-7040	334-1040	334-8040	334-2040
41/64	4-1/2	234-0041	234-1041	334-6041	334-7041	334-1041	334-8041	334-2041
21/32	4-1/2	234-0042	234-1042	334-6042	334-7042	334-1042	334-8042	334-2042
43/64	4-5/8	234-0043	234-1043	334-6043	334-7043	334-1043	334-8043	334-2043
11/16	4-5/8	234-0044	234-1044	334-6044	334-7044	334-1044	334-8044	334-2044
45/64	4-3/4	234-0045	234-1045	334-6045	334-7045	334-1045	334-8045	334-2045
23/32	4-3/4	234-0046	234-1046	334-6046	334-7046	334-1046	334-8046	334-2046
47/64	5 "	234-0047	234-1047	334-6047	334-7047	334-1047	334-8047	334-2047
3/4	5 "	234-0048	234-1048	334-6048	334-7048	334-1048	334-8048	334-2048
49/64	5-1/8	234-0049	234-1049	334-6049	334-7049	334-1049	334-8049	334-2049
25/32	5-1/8	234-0050	234-1050	334-6050	334-7050	334-1050	334-8050	334-2050
51/64	5-1/8	234-0051	234-1051	334-6051	334-7051	334-1051	334-8051	334-2051
13/16	5-1/4	234-0052	234-1052	334-6052	334-7052	334-1052	334-8052	334-2052
53/64	5-3/8	234-0053	234-1053	334-6053	334-7053	334-1053	334-8053	334-2053
27/32	5-3/8	234-0054	234-1054	334-6054	334-7054	334-1054	334-8054	334-2054
55/64	5-1/2	234-0055	234-1055	334-6055	334-7055	334-1055	334-8055	334-2055
7/8	5-1/2	234-0056	234-1056	334-6056	334-7056	334-1056	334-8056	334-2056
57/64	5-5/8	234-0057	234-1057	334-6057	334-7057	334-1057	334-8057	334-2057
29/32	5-5/8	234-0058	234-1058	334-6058	334-7058	334-1058	334-8058	334-2058
59/64	5-3/4	234-0059	234-1059	334-6059	334-7059	334-1059	334-8059	334-2059
15/16	5-3/4	234-0060	234-1060	334-6060	334-7060	334-1060	334-8060	334-2060
61/64	5-7/8	234-0061	234-1061	334-6061	334-7061	334-1061	334-8061	334-2061
31/32	5-7/8	234-0062	234-1062	334-6062	334-7062	334-1062	334-8062	334-2062
63/64	6 "	234-0063	234-1063	334-6063	334-7063	334-1063	334-8063	334-2063
1 "	6 "	234-0100	234-1100	334-6100	334-7100	334-1100	334-8100	334-2100
1-1/16	6-1/4	234-0104	234-1104	334-6104	334-7104	334-1104	334-8104	334-2104
1-1/8	6-3/8	234-0108	234-1108	334-6108	334-7108	334-1108	334-8108	334-2108
1-3/16	6-5/8	234-0112	234-1112	334-6112	334-7112	334-1112	334-8112	334-2112
1-1/4	6-3/4	234-0116	234-1116	334-6116	334-7116	334-1116	334-8116	334-2116
1-5/16	7 "	234-0120	234-1120	334-6120	334-7120	334-1120	334-8120	334-2120
1-3/8	7-1/8	234-0124	234-1124	334-6124	334-7124	334-1124	334-8124	334-2124
1-7/16	7-3/8	234-0128	234-1128	334-6128	334-7128	334-1128	334-8128	334-2128
1-1/2	7-1/2	234-0132	234-1132	334-6132	334-7132	334-1132	334-8132	334-2132
1-9/16	7-3/4	234-0136	234-1136	334-6136	334-7136	334-1136	334-8136	334-2136
1-5/8	7-3/4	234-0140	234-1140	334-6140	334-7140	334-1140	334-8140	334-2140
1-11/16	8 "	234-0144	234-1144	334-6144	334-7144	334-1144	334-8144	334-2144
1-3/4	8 "	234-0148	234-1148	334-6148	334-7148	334-1148	334-8148	334-2148
1-13/16	8-1/4	234-0152	234-1152	334-6152	334-7152	334-1152	334-8152	334-2152
1-7/8	8-1/4	234-0156	234-1156	334-6156	334-7156	334-1156	334-8156	334-2156
1-15/16	8-1/2	234-0160	234-1160	334-6160	334-7160	334-1160	334-8160	334-2160
2 "	8-1/2	234-0200	234-1200	334-6200	334-7200	334-1200	334-8200	334-2200

WWW.PRECOTOOLS.CN

Cutting Tools

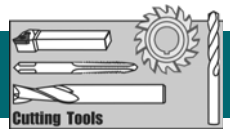

SCREW MACHINE DRILLS continued



Number Sizes

Size	Overall Length	Rolled Black Oxide Model No.	Rolled Polished Model No.	Milled Black Oxide Model No.	Milled Polished Model No.	Ground Black Oxide Model No.	Ground Bright Model No.	Ground Tin-Coated Model No.
1	2-7/16 "	234-0201	234-1201	334-6201	334-7201	334-1201	334-8201	334-2201
2	2-7/16	234-0202	234-1202	334-6202	334-7202	334-1202	334-8202	334-2202
3	2-3/8	234-0203	234-1203	334-6203	334-7203	334-1203	334-8203	334-2203
4	2-3/8	234-0204	234-1204	334-6204	334-7204	334-1204	334-8204	334-2204
5	2-3/8	234-0205	234-1205	334-6205	334-7205	334-1205	334-8205	334-2205
6	2-3/8	234-0206	234-1206	334-6206	334-7206	334-1206	334-8206	334-2206
7	2-1/4	234-0207	234-1207	334-6207	334-7207	334-1207	334-8207	334-2207
8	2-1/4	234-0208	234-1208	334-6208	334-7208	334-1208	334-8208	334-2208
9	2-1/4	234-0209	234-1209	334-6209	334-7209	334-1209	334-8209	334-2209
10	2-1/4	234-0210	234-1210	334-6210	334-7210	334-1210	334-8210	334-2210
11	2-1/4	234-0211	234-1211	334-6211	334-7211	334-1211	334-8211	334-2211
12	2-1/4	234-0212	234-1212	334-6212	334-7212	334-1212	334-8212	334-2212
13	2-3/16	234-0213	234-1213	334-6213	334-7213	334-1213	334-8213	334-2213
14	2-3/16	234-0214	234-1214	334-6214	334-7214	334-1214	334-8214	334-2214
15	2-3/16	234-0215	234-1215	334-6215	334-7215	334-1215	334-8215	334-2215
16	2-3/16	234-0216	234-1216	334-6216	334-7216	334-1216	334-8216	334-2216
17	2-3/16	234-0217	234-1217	334-6217	334-7217	334-1217	334-8217	334-2217
18	2-1/8	234-0218	234-1218	334-6218	334-7218	334-1218	334-8218	334-2218
19	2-1/8	234-0219	234-1219	334-6219	334-7219	334-1219	334-8219	334-2219
20	2-1/8	234-0220	234-1220	334-6220	334-7220	334-1220	334-8220	334-2220
21	2-1/8	234-0221	234-1221	334-6221	334-7221	334-1221	334-8221	334-2221
22	2-1/8	234-0222	234-1222	334-6222	334-7222	334-1222	334-8222	334-2222
23	2-1/16	234-0223	234-1223	334-6223	334-7223	334-1223	334-8223	334-2223
24	2-1/16	234-0224	234-1224	334-6224	334-7224	334-1224	334-8224	334-2224
25	2-1/16	234-0225	234-1225	334-6225	334-7225	334-1225	334-8225	334-2225
26	2-1/16	234-0226	234-1226	334-6226	334-7226	334-1226	334-8226	334-2226
27	2-1/16	234-0227	234-1227	334-6227	334-7227	334-1227	334-8227	334-2227
28	1-15/16	234-0228	234-1228	334-6228	334-7228	334-1228	334-8228	334-2228
29	1-15/16	234-0229	234-1229	334-6229	334-7229	334-1229	334-8229	334-2229
30	1-15/16	234-0230	234-1230	334-6230	334-7230	334-1230	334-8230	334-2230
31	1-7/8	234-0231	234-1231	334-6231	334-7231	334-1231	334-8231	334-2231
32	1-7/8	234-0232	234-1232	334-6232	334-7232	334-1232	334-8232	334-2232
33	1-7/8	234-0233	234-1233	334-6233	334-7233	334-1233	334-8233	334-2233
34	1-7/8	234-0234	234-1234	334-6234	334-7234	334-1234	334-8234	334-2234
35	1-7/8	234-0235	234-1235	334-6235	334-7235	334-1235	334-8235	334-2235
36	1-13/16	234-0236	234-1236	334-6236	334-7236	334-1236	334-8236	334-2236
37	1-13/16	234-0237	234-1237	334-6237	334-7237	334-1237	334-8237	334-2237
38	1-13/16	234-0238	234-1238	334-6238	334-7238	334-1238	334-8238	334-2238
39	1-13/16	234-0239	234-1239	334-6239	334-7239	334-1239	334-8239	334-2239
40	1-13/16	234-0240	234-1240	334-6240	334-7240	334-1240	334-8240	334-2240
41	1-13/16	234-0241	234-1241	334-6241	334-7241	334-1241	334-8241	334-2241
42	1-3/4	234-0242	234-1242	334-6242	334-7242	334-1242	334-8242	334-2242
43	1-3/4	234-0243	234-1243	334-6243	334-7243	334-1243	334-8243	334-2243
44	1-3/4	234-0244	234-1244	334-6244	334-7244	334-1244	334-8244	334-2244
45	1-3/4	234-0245	234-1245	334-6245	334-7245	334-1245	334-8245	334-2245
46	1-3/4	234-0246	234-1246	334-6246	334-7246	334-1246	334-8246	334-2246
47	1-3/4	234-0247	234-1247	334-6247	334-7247	334-1247	334-8247	334-2247
48	1-11/16	234-0248	234-1248	334-6248	334-7248	334-1248	334-8248	334-2248
49	1-11/16	234-0249	234-1249	334-6249	334-7249	334-1249	334-8249	334-2249
50	1-11/16	234-0250	234-1250	334-6250	334-7250	334-1250	334-8250	334-2250
51	1-11/16	234-0251	234-1251	334-6251	334-7251	334-1251	334-8251	334-2251
52	1-11/16	234-0252	234-1252	334-6252	334-7252	334-1252	334-8252	334-2252
53	1-5/8	234-0253	234-1253	334-6253	334-7253	334-1253	334-8253	334-2253
54	1-5/8	234-0254	234-1254	334-6254	334-7254	334-1254	334-8254	334-2254
55	1-5/8	234-0255	234-1255	334-6255	334-7255	334-1255	334-8255	334-2255
56	1-3/8	234-0256	234-1256	334-6256	334-7256	334-1256	334-8256	334-2256
57	1-3/8	234-0257	234-1257	334-6257	334-7257	334-1257	334-8257	334-2257
58	1-3/8	234-0258	234-1258	334-6258	334-7258	334-1258	334-8258	334-2258
59	1-3/8	234-0259	234-1259	334-6259	334-7259	334-1259	334-8259	334-2259
60	1-3/8	234-0260	234-1260	334-6260	334-7260	334-1260	334-8260	334-2260

Letter Sizes

Overall Size/Length	Rolled Black Oxide Model No.	Rolled Polished Model No.	Milled Black Oxide Model No.	Milled Polished Model No.	Ground Black Oxide Model No.	Ground Bright Model No.	Ground Tin-Coated Model No.
A 2-7/16"	234-0301	234-1301	334-6301	334-7301	334-1301	334-8301	334-2301
B 2-1/2	234-0302	234-1302	334-6302	334-7302	334-1302	334-8302	334-2302
C 2-1/2	234-0303	234-1303	334-6303	334-7303	334-1303	334-8303	334-2303
D 2-1/2	234-0304	234-1304	334-6304	334-7304	334-1304	334-8304	334-2304
E 2-1/2	234-0305	234-1305	334-6305	334-7305	334-1305	334-8305	334-2305
F 2-5/8	234-0306	234-1306	334-6306	334-7306	334-1306	334-8306	334-2306
G 2-5/8	234-0307	234-1307	334-6307	334-7307	334-1307	334-8307	334-2307
H 2-11/16	234-0308	234-1308	334-6308	334-7308	334-1308	334-8308	334-2308
I 2-11/16	234-0309	234-1309	334-6309	334-7309	334-1309	334-8309	334-2309
J 2-1/16	234-0310	234-1310	334-6310	334-7310	334-1310	334-8310	334-2310
K 2-1/16	234-0311	234-1311	334-6311	334-7311	334-1311	334-8311	334-2311
L 2-3/4	234-0312	234-1312	334-6312	334-7312	334-1312	334-8312	334-2312
M 2-3/4	234-0313	234-1313	334-6313	334-7313	334-1313	334-8313	334-2313
N 2-3/16	234-0314	234-1314	334-6314	334-7314	334-1314	334-8314	334-2314
O 2-5/16	234-0315	234-1315	334-6315	334-7315	334-1315	334-8315	334-2315
P 2-5/16	234-0316	234-1316	334-6316	334-7316	334-1316	334-8316	334-2316
Q 3"	234-0317	234-1317	334-6317	334-7317	334-1317	334-8317	334-2317
R 3"	234-0318	234-1318	334-6318	334-7318	334-1318	334-8318	334-2318
S 3-1/16	234-0319	234-1319	334-6319	334-7319	334-1319	334-8319	334-2319
T 3-1/16	234-0320	234-1320	334-6320	334-7320	334-1320	334-8320	334-2320
U 3-1/8	234-0321	234-1321	334-6321	334-7321	334-1321	334-8321	334-2321
V 3-1/4	234-0322	234-1322	334-6322	334-7322	334-1322	334-8322	334-2322
W 3-1/4	234-0323	234-1323	334-6323	334-7323	334-1323	334-8323	334-2323
X 3-5/16	234-0324	234-1324	334-6324	334-7324	334-1324	334-8324	334-2324
Y 3-5/16	234-0325	234-1325	334-6325	334-7325	334-1325	334-8325	334-2325
Z 3-3/8	234-0326	234-1326	334-6326	334-7326	334-1326	334-8326	334-2326

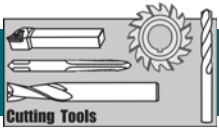

Cutting Tools

SPLIT POINT JOBBERS DRILLS

High Speed Steel, 135° Point

- The 135° split point is self centering, and reduces shift at the drill point.



Fractional Sizes

Size	Flute Length	Overall Length	Rolled Black Oxide Model No.	Rolled Polished Model No.	Milled Black Oxide Model No.	Milled Polished Model No.	Ground Black Oxide Model No.	Ground Bright Model No.	Ground Tin-Coated Model No.
1/64	3/16	3/4	134-6001	134-7001	134-4001	134-5001	134-2001	134-3001	134-1001
1/32	1/2	1-3/8	134-6002	134-7002	134-4002	134-5002	134-2002	134-3002	134-1002
3/64	3/4	1-3/4	134-6003	134-7003	134-4003	134-5003	134-2003	134-3003	134-1003
1/16	7/8	1-7/8	134-6004	134-7004	134-4004	134-5004	134-2004	134-3004	134-1004
5/64	1 "	2 "	134-6005	134-7005	134-4005	134-5005	134-2005	134-3005	134-1005
3/32	1-1/4	2-1/4	134-6006	134-7006	134-4006	134-5006	134-2006	134-3006	134-1006
7/64	1-1/2	2-5/8	134-6007	134-7007	134-4007	134-5007	134-2007	134-3007	134-1007
1/8	1-5/8	2-3/4	134-6008	134-7008	134-4008	134-5008	134-2008	134-3008	134-1008
9/64	1-3/4	2-7/8	134-6009	134-7009	134-4009	134-5009	134-2009	134-3009	134-1009
5/32	2 "	3-1/8	134-6010	134-7010	134-4010	134-5010	134-2010	134-3010	134-1010
11/64	2-1/8	3-1/4	134-6011	134-7011	134-4011	134-5011	134-2011	134-3011	134-1011
3/16	2-5/16	3-1/2	134-6012	134-7012	134-4012	134-5012	134-2012	134-3012	134-1012
13/64	2-7/16	3-5/8	134-6013	134-7013	134-4013	134-5013	134-2013	134-3013	134-1013
7/32	2-1/2	3-3/4	134-6014	134-7014	134-4014	134-5014	134-2014	134-3014	134-1014
15/64	2-5/8	3-7/8	134-6015	134-7015	134-4015	134-5015	134-2015	134-3015	134-1015
1/4	2-3/4	4 "	134-6016	134-7016	134-4016	134-5016	134-2016	134-3016	134-1016
17/64	2-7/8	4-1/8	134-6017	134-7017	134-4017	134-5017	134-2017	134-3017	134-1017
9/32	2-5/16	4-1/4	134-6018	134-7018	134-4018	134-5018	134-2018	134-3018	134-1018
19/64	3-1/16	4-3/8	134-6019	134-7019	134-4019	134-5019	134-2019	134-3019	134-1019
5/16	3-3/16	4-1/2	134-6020	134-7020	134-4020	134-5020	134-2020	134-3020	134-1020
21/64	3-5/16	4-5/8	134-6021	134-7021	134-4021	134-5021	134-2021	134-3021	134-1021
11/32	3-7/16	4-3/4	134-6022	134-7022	134-4022	134-5022	134-2022	134-3022	134-1022
23/64	3-1/2	4-7/8	134-6023	134-7023	134-4023	134-5023	134-2023	134-3023	134-1023
3/8	3-5/8	5 "	134-6024	134-7024	134-4024	134-5024	134-2024	134-3024	134-1024
25/64	3-3/4	5-1/8	134-6025	134-7025	134-4025	134-5025	134-2025	134-3025	134-1025
13/32	3-7/8	5-1/4	134-6026	134-7026	134-4026	134-5026	134-2026	134-3026	134-1026
27/64	3-5/16	5-3/8	134-6027	134-7027	134-4027	134-5027	134-2027	134-3027	134-1027
7/16	4-1/16	5-1/2	134-6028	134-7028	134-4028	134-5028	134-2028	134-3028	134-1028
29/64	4-3/16	5-5/8	134-6029	134-7029	134-4029	134-5029	134-2029	134-3029	134-1029
15/32	4-5/16	5-3/4	134-6030	134-7030	134-4030	134-5030	134-2030	134-3030	134-1030
31/64	4-3/8	5-7/8	134-6031	134-7031	134-4031	134-5031	134-2031	134-3031	134-1031
1/2	4-1/2	6 "	134-6032	134-7032	134-4032	134-5032	134-2032	134-3032	134-1032

Letter Sizes

Size	Overall Length	Rolled Black Oxide Model No.	Rolled Polished Model No.	Milled Black Oxide Model No.	Milled Polished Model No.	Ground Black Oxide Model No.	Ground Bright Model No.	Ground Tin-Coated Model No.
A	3-7/8	134-6201	134-7201	134-4201	134-5201	134-2201	134-3201	134-1201
B	4 "	134-6202	134-7202	134-4202	134-5202	134-2202	134-3202	134-1202
C	4 "	134-6203	134-7203	134-4203	134-5203	134-2203	134-3203	134-1203
D	4 "	134-6204	134-7204	134-4204	134-5204	134-2204	134-3204	134-1204
E	4 "	134-6205	134-7205	134-4205	134-5205	134-2205	134-3205	134-1205
F	4-1/8	134-6206	134-7206	134-4206	134-5206	134-2206	134-3206	134-1206
G	4-1/8	134-6207	134-7207	134-4207	134-5207	134-2207	134-3207	134-1207
H	4-1/8	134-6208	134-7208	134-4208	134-5208	134-2208	134-3208	134-1208
I	4-1/8	134-6209	134-7209	134-4209	134-5209	134-2209	134-3209	134-1209
J	4-1/8	134-6210	134-7210	134-4210	134-5210	134-2210	134-3210	134-1210
K	4-1/4	134-6211	134-7211	134-4211	134-5211	134-2211	134-3211	134-1211
L	4-1/4	134-6212	134-7212	134-4212	134-5212	134-2212	134-3212	134-1212
M	4-3/8	134-6213	134-7213	134-4213	134-5213	134-2213	134-3213	134-1213
N	4-3/8	134-6214	134-7214	134-4214	134-5214	134-2214	134-3214	134-1214
O	4-1/2	134-6215	134-7215	134-4215	134-5215	134-2215	134-3215	134-1215
P	4-5/8	134-6216	134-7216	134-4216	134-5216	134-2216	134-3216	134-1216
Q	4-3/4	134-6217	134-7217	134-4217	134-5217	134-2217	134-3217	134-1217
R	4-3/4	134-6218	134-7218	134-4218	134-5218	134-2218	134-3218	134-1218
S	4-7/8	134-6219	134-7219	134-4219	134-5219	134-2219	134-3219	134-1219
T	4-7/8	134-6220	134-7220	134-4220	134-5220	134-2220	134-3220	134-1220
U	5 "	134-6221	134-7221	134-4221	134-5221	134-2221	134-3221	134-1221
V	5 "	134-6222	134-7222	134-4222	134-5222	134-2222	134-3222	134-1222
W	5-1/8	134-6223	134-7223	134-4223	134-5223	134-2223	134-3223	134-1223
X	5-1/8	134-6224	134-7224	134-4224	134-5224	134-2224	134-3224	134-1224
Y	5-1/4	134-6225	134-7225	134-4225	134-5225	134-2225	134-3225	134-1225
Z	5-1/4	134-6226	134-7226	134-4226	134-5226	134-2226	134-3226	134-1226

WWW.PRECOTOOLS.CN

Cutting Tools

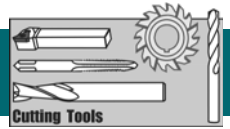

SPLIT POINT JOBBERS DRILLS continued

Number Sizes



Size	Overall Length	Rolled Black Oxide Model No.	Rolled Polished Model No.	Milled Black Oxide Model No.	Milled Polished Model No.	Ground Black Oxide Model No.	Ground Bright Model No.	Ground Tin-Coated Model No.
1	3-7/8	134-6101	134-7101	134-4101	134-5101	134-2101	134-3101	134-1101
2	3-7/8	134-6102	134-7102	134-4102	134-5102	134-2102	134-3102	134-1102
3	3-3/4	134-6103	134-7103	134-4103	134-5103	134-2103	134-3103	134-1103
4	3-3/4	134-6104	134-7104	134-4104	134-5104	134-2104	134-3104	134-1104
5	3-3/4	134-6105	134-7105	134-4105	134-5105	134-2105	134-3105	134-1105
6	3-3/4	134-6106	134-7106	134-4106	134-5106	134-2106	134-3106	134-1106
7	3-5/8	134-6107	134-7107	134-4107	134-5107	134-2107	134-3107	134-1107
8	3-5/8	134-6108	134-7108	134-4108	134-5108	134-2108	134-3108	134-1108
9	3-5/8	134-6109	134-7109	134-4109	134-5109	134-2109	134-3109	134-1109
10	3-5/8	134-6110	134-7110	134-4110	134-5110	134-2110	134-3110	134-1110
11	3-1/2	134-6111	134-7111	134-4111	134-5111	134-2111	134-3111	134-1111
12	3-1/2	134-6112	134-7112	134-4112	134-5112	134-2112	134-3112	134-1112
13	3-1/2	134-6113	134-7113	134-4113	134-5113	134-2113	134-3113	134-1113
14	3-3/8	134-6114	134-7114	134-4114	134-5114	134-2114	134-3114	134-1114
15	3-3/8	134-6115	134-7115	134-4115	134-5115	134-2115	134-3115	134-1115
16	3-3/8	134-6116	134-7116	134-4116	134-5116	134-2116	134-3116	134-1116
17	3-3/8	134-6117	134-7117	134-4117	134-5117	134-2117	134-3117	134-1117
18	3-1/4	134-6118	134-7118	134-4118	134-5118	134-2118	134-3118	134-1118
19	3-1/4	134-6119	134-7119	134-4119	134-5119	134-2119	134-3119	134-1119
20	3-1/4	134-6120	134-7120	134-4120	134-5120	134-2120	134-3120	134-1120
21	3-1/4	134-6121	134-7121	134-4121	134-5121	134-2121	134-3121	134-1121
22	3-1/8	134-6122	134-7122	134-4122	134-5122	134-2122	134-3122	134-1122
23	3-1/8	134-6123	134-7123	134-4123	134-5123	134-2123	134-3123	134-1123
24	3-1/8	134-6124	134-7124	134-4124	134-5124	134-2124	134-3124	134-1124
25	3 "	134-6125	134-7125	134-4125	134-5125	134-2125	134-3125	134-1125
26	3 "	134-6126	134-7126	134-4126	134-5126	134-2126	134-3126	134-1126
27	3 "	134-6127	134-7127	134-4127	134-5127	134-2127	134-3127	134-1127
28	2-7/8	134-6128	134-7128	134-4128	134-5128	134-2128	134-3128	134-1128
29	2-7/8	134-6129	134-7129	134-4129	134-5129	134-2129	134-3129	134-1129
30	2-3/4	134-6130	134-7130	134-4130	134-5130	134-2130	134-3130	134-1130
31	2-3/4	134-6131	134-7131	134-4131	134-5131	134-2131	134-3131	134-1131
32	2-3/4	134-6132	134-7132	134-4132	134-5132	134-2132	134-3132	134-1132
33	2-5/8	134-6133	134-7133	134-4133	134-5133	134-2133	134-3133	134-1133
34	2-5/8	134-6134	134-7134	134-4134	134-5134	134-2134	134-3134	134-1134
35	2-5/8	134-6135	134-7135	134-4135	134-5135	134-2135	134-3135	134-1135
36	2-1/2	134-6136	134-7136	134-4136	134-5136	134-2136	134-3136	134-1136
37	2-1/2	134-6137	134-7137	134-4137	134-5137	134-2137	134-3137	134-1137
38	2-1/2	134-6138	134-7138	134-4138	134-5138	134-2138	134-3138	134-1138
39	2-3/8	134-6139	134-7139	134-4139	134-5139	134-2139	134-3139	134-1139
40	2-3/8	134-6140	134-7140	134-4140	134-5140	134-2140	134-3140	134-1140
41	2-3/8	134-6141	134-7141	134-4141	134-5141	134-2141	134-3141	134-1141
42	2-1/4	134-6142	134-7142	134-4142	134-5142	134-2142	134-3142	134-1142
43	2-1/4	134-6143	134-7143	134-4143	134-5143	134-2143	134-3143	134-1143
44	2-1/4	134-6144	134-7144	134-4144	134-5144	134-2144	134-3144	134-1144
45	2-1/8	134-6145	134-7145	134-4145	134-5145	134-2145	134-3145	134-1145
46	2-1/8	134-6146	134-7146	134-4146	134-5146	134-2146	134-3146	134-1146
47	2 "	134-6147	134-7147	134-4147	134-5147	134-2147	134-3147	134-1147
48	2 "	134-6148	134-7148	134-4148	134-5148	134-2148	134-3148	134-1148
49	2 "	134-6149	134-7149	134-4149	134-5149	134-2149	134-3149	134-1149
50	2 "	134-6150	134-7150	134-4150	134-5150	134-2150	134-3150	134-1150
51	2 "	134-6151	134-7151	134-4151	134-5151	134-2151	134-3151	134-1151
52	1-7/8	134-6152	134-7152	134-4152	134-5152	134-2152	134-3152	134-1152
53	1-7/8	134-6153	134-7153	134-4153	134-5153	134-2153	134-3153	134-1153
54	1-7/8	134-6154	134-7154	134-4154	134-5154	134-2154	134-3154	134-1154
55	1-7/8	134-6155	134-7155	134-4155	134-5155	134-2155	134-3155	134-1155
56	1-3/4	134-6156	134-7156	134-4156	134-5156	134-2156	134-3156	134-1156
57	1-3/4	134-6157	134-7157	134-4157	134-5157	134-2157	134-3157	134-1157
58	1-5/8	134-6158	134-7158	134-4158	134-5158	134-2158	134-3158	134-1158
59	1-5/8	134-6159	134-7159	134-4159	134-5159	134-2159	134-3159	134-1159
60	1-5/8	134-6160	134-7160	134-4160	134-5160	134-2160	134-3160	134-1160
61	1-5/8	134-6161	134-7161	134-4161	134-5161	134-2161	134-3161	134-1161
62	1-1/2	134-6162	134-7162	134-4162	134-5162	134-2162	134-3162	134-1162
63	1-1/2	134-6163	134-7163	134-4163	134-5163	134-2163	134-3163	134-1163
64	1-1/2	134-6164	134-7164	134-4164	134-5164	134-2164	134-3164	134-1164
65	1-1/2	134-6165	134-7165	134-4165	134-5165	134-2165	134-3165	134-1165
66	1-3/8	134-6166	134-7166	134-4166	134-5166	134-2166	134-3166	134-1166
67	1-3/8	134-6167	134-7167	134-4167	134-5167	134-2167	134-3167	134-1167
68	1-3/8	134-6168	134-7168	134-4168	134-5168	134-2168	134-3168	134-1168
69	1-3/8	134-6169	134-7169	134-4169	134-5169	134-2169	134-3169	134-1169
70	1-1/4	134-6170	134-7170	134-4170	134-5170	134-2170	134-3170	134-1170
71	1-1/4	134-6171	134-7171	134-4171	134-5171	134-2171	134-3171	134-1171
72	1-1/8	134-6172	134-7172	134-4172	134-5172	134-2172	134-3172	134-1172
73	1-1/8	134-6173	134-7173	134-4173	134-5173	134-2173	134-3173	134-1173
74	1-1/8	134-6174	134-7174	134-4174	134-5174	134-2174	134-3174	134-1174
75	1-1/8	134-6175	134-7175	134-4175	134-5175	134-2175	134-3175	134-1175
76	7/8	134-6176	134-7176	134-4176	134-5176	134-2176	134-3176	134-1176
77	7/8	134-6177	134-7177	134-4177	134-5177	134-2177	134-3177	134-1177
78	7/8	134-6178	134-7178	134-4178	134-5178	134-2178	134-3178	134-1178
79	3/4	134-6179	134-7179	134-4179	134-5179	134-2179	134-3179	134-1179
80	3/4	134-6180	134-7180	134-4180	134-5180	134-2180	134-3180	134-1180

Cutting Tools



METRIC STRAIGHT SHANK TWIST DRILL

High Speed Steel, DIN 338



Size	Flute length	Overall Length	Rolled Black Oxide			Ground Black Oxide			Size	Flute length	Overall Length	Rolled Black Oxide			Ground Black Oxide		
			Model No.	Rolled Polished Model No.	Model No.	Ground Bright Model No.	Ground Tin-Coated Model No.	Model No.				Rolled Polished Model No.	Model No.	Ground Bright Model No.	Ground Tin-Coated Model No.		
0.20mm	2.5	19	201-0020	215-0020	205-0020	206-0020	207-0020	4.00mm	43	75	201-0400	215-0400	205-0400	206-0400	207-0400		
0.30mm	3	19	201-0030	215-0030	205-0030	206-0030	207-0030	4.05mm	43	75	201-0405	215-0405	205-0405	206-0405	207-0405		
0.50mm	6	22	201-0050	215-0050	205-0050	206-0050	207-0050	4.10mm	43	75	201-0410	215-0410	205-0410	206-0410	207-0410		
0.55mm	7	24	201-0055	215-0055	205-0055	206-0055	207-0055	4.15mm	43	75	201-0415	215-0415	205-0415	206-0415	207-0415		
0.60mm	7	24	201-0060	215-0060	205-0060	206-0060	207-0060	4.20mm	43	75	201-0420	215-0420	205-0420	206-0420	207-0420		
0.65mm	8	26	201-0065	215-0065	205-0065	206-0065	207-0065	4.25mm	43	75	201-0425	215-0425	205-0425	206-0425	207-0425		
0.70mm	9	28	201-0070	215-0070	205-0070	206-0070	207-0070	4.30mm	47	80	201-0430	215-0430	205-0430	206-0430	207-0430		
0.75mm	9	28	201-0075	215-0075	205-0075	206-0075	207-0075	4.35mm	47	80	201-0435	215-0435	205-0435	206-0435	207-0435		
0.80mm	10	30	201-0080	215-0080	205-0080	206-0080	207-0080	4.40mm	47	80	201-0440	215-0440	205-0440	206-0440	207-0440		
0.85mm	11	32	201-0085	215-0085	205-0085	206-0085	207-0085	4.45mm	47	80	201-0445	215-0445	205-0445	206-0445	207-0445		
0.90mm	11	32	201-0090	215-0090	205-0090	206-0090	207-0090	4.50mm	47	80	201-0450	215-0450	205-0450	206-0450	207-0450		
0.95mm	11	32	201-0095	215-0095	205-0095	206-0095	207-0095	4.55mm	47	80	201-0455	215-0455	205-0455	206-0455	207-0455		
0.98mm	12	34	201-0098	215-0098	205-0098	206-0098	207-0098	4.60mm	47	80	201-0460	215-0460	205-0460	206-0460	207-0460		
1.00mm	12	34	201-0100	215-0100	205-0100	206-0100	207-0100	4.65mm	47	80	201-0465	215-0465	205-0465	206-0465	207-0465		
1.05mm	12	34	201-0105	215-0105	205-0105	206-0105	207-0105	4.70mm	47	80	201-0470	215-0470	205-0470	206-0470	207-0470		
1.10mm	14	36	201-0110	215-0110	205-0110	206-0110	207-0110	4.75mm	47	80	201-0475	215-0475	205-0475	206-0475	207-0475		
1.15mm	14	36	201-0115	215-0115	205-0115	206-0115	207-0115	4.80mm	52	86	201-0480	215-0480	205-0480	206-0480	207-0480		
1.20mm	16	38	201-0120	215-0120	205-0120	206-0120	207-0120	4.85mm	52	86	201-0485	215-0485	205-0485	206-0485	207-0485		
1.25mm	16	38	201-0125	215-0125	205-0125	206-0125	207-0125	4.90mm	52	86	201-0490	215-0490	205-0490	206-0490	207-0490		
1.30mm	16	38	201-0130	215-0130	205-0130	206-0130	207-0130	4.95mm	52	86	201-0495	215-0495	205-0495	206-0495	207-0495		
1.35mm	18	40	201-0135	215-0135	205-0135	206-0135	207-0135	5.00mm	52	86	201-0500	215-0500	205-0500	206-0500	207-0500		
1.40mm	18	40	201-0140	215-0140	205-0140	206-0140	207-0140	5.10mm	52	86	201-0510	215-0510	205-0510	206-0510	207-0510		
1.45mm	18	40	201-0145	215-0145	205-0145	206-0145	207-0145	5.20mm	52	86	201-0520	215-0520	205-0520	206-0520	207-0520		
1.50mm	18	40	201-0150	215-0150	205-0150	206-0150	207-0150	5.25mm	52	86	201-0525	215-0525	205-0525	206-0525	207-0525		
1.55mm	20	43	201-0155	215-0155	205-0155	206-0155	207-0155	5.30mm	52	86	201-0530	215-0530	205-0530	206-0530	207-0530		
1.60mm	20	43	201-0160	215-0160	205-0160	206-0160	207-0160	5.40mm	57	93	201-0540	215-0540	205-0540	206-0540	207-0540		
1.65mm	20	43	201-0165	215-0165	205-0165	206-0165	207-0165	5.50mm	57	93	201-0550	215-0550	205-0550	206-0550	207-0550		
1.70mm	20	43	201-0170	215-0170	205-0170	206-0170	207-0170	5.60mm	57	93	201-0560	215-0560	205-0560	206-0560	207-0560		
1.75mm	22	48	201-0175	215-0175	205-0175	206-0175	207-0175	5.70mm	57	93	201-0570	215-0570	205-0570	206-0570	207-0570		
1.80mm	22	48	201-0180	215-0180	205-0180	206-0180	207-0180	5.75mm	57	93	201-0575	215-0575	205-0575	206-0575	207-0575		
1.85mm	22	48	201-0185	215-0185	205-0185	206-0185	207-0185	5.80mm	57	93	201-0580	215-0580	205-0580	206-0580	207-0580		
1.90mm	22	48	201-0190	215-0190	205-0190	206-0190	207-0190	5.90mm	57	93	201-0590	215-0590	205-0590	206-0590	207-0590		
1.95mm	24	49	201-0195	215-0195	205-0195	206-0195	207-0195	6.00mm	57	93	201-0600	215-0600	205-0600	206-0600	207-0600		
2.00mm	24	49	201-0200	215-0200	205-0200	206-0200	207-0200	6.10mm	63	101	201-0610	215-0610	205-0610	206-0610	207-0610		
2.05mm	24	49	201-0205	215-0205	205-0205	206-0205	207-0205	6.20mm	63	101	201-0620	215-0620	205-0620	206-0620	207-0620		
2.10mm	24	49	201-0210	215-0210	205-0210	206-0210	207-0210	6.25mm	63	101	201-0625	215-0625	205-0625	206-0625	207-0625		
2.15mm	27	53	201-0215	215-0215	205-0215	206-0215	207-0215	6.30mm	63	101	201-0630	215-0630	205-0630	206-0630	207-0630		
2.20mm	27	53	201-0220	215-0220	205-0220	206-0220	207-0220	6.35mm	63	101	201-0635	215-0635	205-0635	206-0635	207-0635		
2.25mm	27	53	201-0225	215-0225	205-0225	206-0225	207-0225	6.40mm	63	101	201-0640	215-0640	205-0640	206-0640	207-0640		
2.30mm	27	53	201-0230	215-0230	205-0230	206-0230	207-0230	6.50mm	63	101	201-0650	215-0650	205-0650	206-0650	207-0650		
2.35mm	27	53	201-0235	215-0235	205-0235	206-0235	207-0235	6.60mm	63	101	201-0660	215-0660	205-0660	206-0660	207-0660		
2.40mm	30	57	201-0240	215-0240	205-0240	206-0240	207-0240	6.70mm	63	101	201-0670	215-0670	205-0670	206-0670	207-0670		
2.45mm	30	57	201-0245	215-0245	205-0245	206-0245	207-0245	6.75mm	69	109	201-0675	215-0675	205-0675	206-0675	207-0675		
2.50mm	30	57	201-0250	215-0250	205-0250	206-0250	207-0250	6.80mm	69	109	201-0680	215-0680	205-0680	206-0680	207-0680		
2.55mm	30	57	201-0255	215-0255	205-0255	206-0255	207-0255	6.90mm	69	109	201-0690	215-0690	205-0690	206-0690	207-0690		
2.60mm	30	57	201-0260	215-0260	205-0260	206-0260	207-0260	7.00mm	69	109	201-0700	215-0700	205-0700	206-0700	207-0700		
2.65mm	30	57	201-0265	215-0265	205-0265	206-0265	207-0265	7.10mm	69	109	201-0710	215-0710	205-0710	206-0710	207-0710		
2.70mm	33	61	201-0270	215-0270	205-0270	206-0270	207-0270	7.20mm	69	109	201-0720	215-0720	205-0720	206-0720	207-0720		
2.75mm	33	61	201-0275	215-0275	205-0275	206-0275	207-0275	7.25mm	69	109	201-0725	215-0725	205-0725	206-0725	207-0725		
2.80mm	33	61	201-0280	215-0280	205-0280	206-0280	207-0280	7.30mm	69	109	201-0730	215-0730	205-0730	206-0730	207-0730		
2.85mm	33	61	201-0285	215-0285	205-0285	206-0285	207-0285	7.40mm	69	109	201-0740	215-0740	205-0740	206-0740	207-0740		
2.90mm	33	61	201-0290	215-0290	205-0290	206-0290	207-0290	7.50mm	69	109	201-0750	215-0750	205-0750	206-0750	207-0750		
2.95mm	33	61	201-0295	215-0295	205-0295	206-0295	207-0295	7.60mm	75	117	201-0760	215-0760	205-0760	206-0760	207-0760		
3.00mm	33	61	201-0300	215-0300	205-0300	206-0300	207-0300	7.70mm	75	117	201-0770	215-0770	205-0770	206-0770	207-0770		
3.05mm	36	65	201-0305	215-0305	205-0305	206-0305	207-0305	7.75mm	75	117	201-0775	215-0775	205-0775	206-0775	207-0775		
3.10mm	36	65	201-0310	215-0310	205-0310	206-0310	207-0310	7.80mm	75	117	201-0780	215-0780	205-0780	206-0780	207-0780		
3.15mm	36	65	201-0315	215-0315	205-0315	206-0315	207-0315	7.90mm	75	117	201-0790	215-0790	205-0790	206-0790	207-0790		
3.20mm	36	65	201-0320	215-0320	205-0320	206-0320	207-0320	8.00mm	75	117	201-0800	215-0800	205-0800	206-0800	207-0800		
3.25mm	36	65	201-0325	215-0325	205-0325	206-0325	207-0325	8.10mm	75	117	201-0810	215-0810	205-0810	206-0810	207-0810		
3.30mm	36	65	201-0330	215-0330	205-0330	206-0330	207-0330	8.20mm	75	117	201-0820	215-0820	205-0820	206-0820	207-0820		
3.35mm	36	65	201-0335	215-0335	205-0335	206-0335	207-0335	8.25mm	75	117	201-0825	215-0825	205-0825	206-0825	207-0825		
3.40mm	39	70	201-0340	215-0340	205-0340	206-0340	207-0340	8.30mm	75	117	201-0830	215-0830	205-0830	206-0830	207-0830		
3.45mm	39	70	201-0345	215-0345	205-0345	206-0345	207-0345	8.40mm	75	117	201-0840	215-0840	205-0840	206-0840	207-0840		
3.50mm	39	70	201-0350	215-0350	205-0350	206-0350	207-0350	8.50mm	75	117	201-0850	215-0850	205-0850	206-0850	207-0850		
3.55mm	39	70	201-0355	215-0355	205-0355	206-0355	207-0355	8.60mm	81	125	201-0860	2					



Cutting Tools

METRIC STRAIGHT SHANK TWIST DRILL continued

High Speed Steel, DIN 338



Size	Flute length	Overall Length	Rolled			Ground			Size	Flute length	Overall Length	Rolled			Ground		
			Black Oxide Model No.	Rolled Polished Model No.	Black Oxide Model No.	Ground Bright Model No.	Ground Tin-Coated Model No.	Black Oxide Model No.				Rolled Polished Model No.	Black Oxide Model No.	Ground Bright Model No.	Ground Tin-Coated Model No.		
9.30mm	81	125	201-0930	215-0930	205-0930	206-0930	207-0930	12.40mm	101	151	201-1240	215-1240	205-1240	206-1240	207-1240		
9.40mm	81	125	201-0940	215-0940	205-0940	206-0940	207-0940	12.50mm	101	151	201-1250	215-1250	205-1250	206-1250	207-1250		
9.50mm	81	125	201-0950	215-0950	205-0950	206-0950	207-0950	12.60mm	101	151	201-1260	215-1260	205-1260	206-1260	207-1260		
9.60mm	87	133	201-0960	215-0960	205-0960	206-0960	207-0960	12.70mm	101	151	201-1270	215-1270	205-1270	206-1270	207-1270		
9.70mm	87	133	201-0970	215-0970	205-0970	206-0970	207-0970	12.75mm	101	151	201-1275	215-1275	205-1275	206-1275	207-1275		
9.75mm	87	133	201-0975	215-0975	205-0975	206-0975	207-0975	12.80mm	101	151	201-1280	215-1280	205-1280	206-1280	207-1280		
9.80mm	87	133	201-0980	215-0980	205-0980	206-0980	207-0980	12.90mm	101	151	201-1290	215-1290	205-1290	206-1290	207-1290		
9.90mm	87	133	201-0990	215-0990	205-0990	206-0990	207-0990	13.00mm	101	151	201-1300	215-1300	205-1300	206-1300	207-1300		
10.00mm	87	133	201-1000	215-1000	205-1000	206-1000	207-1000	13.10mm	101	151	201-1310	215-1310	205-1310	206-1310	207-1310		
10.10mm	87	133	201-1010	215-1010	205-1010	206-1010	207-1010	13.20mm	101	151	201-1320	215-1320	205-1320	206-1320	207-1320		
10.20mm	87	133	201-1020	215-1020	205-1020	206-1020	207-1020	13.25mm	108	160	201-1325	215-1325	205-1325	206-1325	207-1325		
10.25mm	87	133	201-1025	215-1025	205-1025	206-1025	207-1025	13.30mm	108	160	201-1330	215-1330	205-1330	206-1330	207-1330		
10.30mm	87	133	201-1030	215-1030	205-1030	206-1030	207-1030	13.40mm	108	160	201-1340	215-1340	205-1340	206-1340	207-1340		
10.40mm	87	133	201-1040	215-1040	205-1040	206-1040	207-1040	13.50mm	108	160	201-1350	215-1350	205-1350	206-1350	207-1350		
10.50mm	87	133	201-1050	215-1050	205-1050	206-1050	207-1050	13.60mm	108	160	201-1360	215-1360	205-1360	206-1360	207-1360		
10.60mm	94	142	201-1060	215-1060	205-1060	206-1060	207-1060	13.70mm	108	160	201-1370	215-1370	205-1370	206-1370	207-1370		
10.70mm	94	142	201-1070	215-1070	205-1070	206-1070	207-1070	13.75mm	108	160	201-1375	215-1375	205-1375	206-1375	207-1375		
10.75mm	94	142	201-1075	215-1075	205-1075	206-1075	207-1075	13.80mm	108	160	201-1380	215-1380	205-1380	206-1380	207-1380		
10.80mm	94	142	201-1080	215-1080	205-1080	206-1080	207-1080	13.90mm	108	160	201-1390	215-1390	205-1390	206-1390	207-1390		
10.90mm	94	142	201-1090	215-1090	205-1090	206-1090	207-1090	14.00mm	108	160	201-1400	215-1400	205-1400	206-1400	207-1400		
11.00mm	94	142	201-1100	215-1100	205-1100	206-1100	207-1100	14.25mm	114	169	201-1425	215-1425	205-1425	206-1425	207-1425		
11.10mm	94	142	201-1110	215-1110	205-1110	206-1110	207-1110	14.50mm	114	169	201-1450	215-1450	205-1450	206-1450	207-1450		
11.20mm	94	142	201-1120	215-1120	205-1120	206-1120	207-1120	14.75mm	114	169	201-1475	215-1475	205-1475	206-1475	207-1475		
11.25mm	94	142	201-1125	215-1125	205-1125	206-1125	207-1125	15.00mm	114	169	201-1500	215-1500	205-1500	206-1500	207-1500		
11.30mm	94	142	201-1130	215-1130	205-1130	206-1130	207-1130	15.25mm	120	178	201-1525	215-1525	205-1525	206-1525	207-1525		
11.40mm	94	142	201-1140	215-1140	205-1140	206-1140	207-1140	15.50mm	120	178	201-1550	215-1550	205-1550	206-1550	207-1550		
11.50mm	94	142	201-1150	215-1150	205-1150	206-1150	207-1150	15.75mm	120	178	201-1575	215-1575	205-1575	206-1575	207-1575		
11.60mm	94	142	201-1160	215-1160	205-1160	206-1160	207-1160	16.00mm	120	178	201-1600	215-1600	205-1600	206-1600	207-1600		
11.70mm	94	142	201-1170	215-1170	205-1170	206-1170	207-1170	16.50mm	125	187	201-1650	215-1650	205-1650	206-1650	207-1650		
11.75mm	94	142	201-1175	215-1175	205-1175	206-1175	207-1175	17.00mm	125	187	201-1700	215-1700	205-1700	206-1700	207-1700		
11.80mm	94	142	201-1180	215-1180	205-1180	206-1180	207-1180	17.50mm	130	191	201-1750	215-1750	205-1750	206-1750	207-1750		
11.90mm	101	151	201-1190	215-1190	205-1190	206-1190	207-1190	18.00mm	130	191	201-1800	215-1800	205-1800	206-1800	207-1800		
12.00mm	101	151	201-1200	215-1200	205-1200	206-1200	207-1200	18.50mm	135	198	201-1850	215-1850	205-1850	206-1850	207-1850		
12.10mm	101	151	201-1210	215-1210	205-1210	206-1210	207-1210	19.00mm	135	198	201-1900	215-1900	205-1900	206-1900	207-1900		
12.20mm	101	151	201-1220	215-1220	205-1220	206-1220	207-1220	19.50mm	140	205	201-1950	215-1950	205-1950	206-1950	207-1950		
12.25mm	101	151	201-1225	215-1225	205-1225	206-1225	207-1225	20.00mm	140	205	201-2000	215-2000	205-2000	206-2000	207-2000		
12.30mm	101	151	201-1230	215-1230	205-1230	206-1230	207-1230										

WWW.PRECOTOOLS.CN

DRILL STOP SET

Allows drilling to exact depth. Locks onto the bit for drill press depth precision.



Model No.300-0007
7pcs/set 1/8" 3/16", 1/4" 5/16" 3/8"
7/16", 1/2"

Model No.300-0004
4pcs/set 5/8", 3/4", 7/8", 1"

DRILL GUIDE

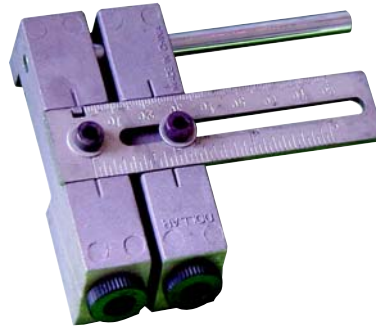

For drilling perfect pocket holes in face frames quickly and easily.

Model No. 830-2020

Cutting Tools

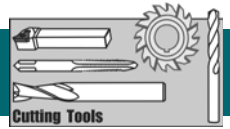

METRIC TWIST DRILL

High Speed Steel, DIN 1897



Size	Flute Length	Overall Length	Rolled			Ground			Size	Flute Length	Overall Length	Rolled			Ground		
			Black Oxide Model No.	Polished Model No.	Model No.	Black Oxide Model No.	Bright Model No.	Tin-Coated Model No.				Black Oxide Model No.	Bright Model No.	Tin-Coated Model No.			
1.00mm	6	26	202-0010	202-1010	202-2010	202-4010	202-5010	8.0mm	37	79	202-0080	202-1080	202-2080	202-4080	202-5080		
1.10mm	7	28	202-0011	202-1011	202-2011	202-4011	202-5011	8.5mm	37	79	202-0085	202-1085	202-2085	202-4085	202-5085		
1.20mm	8	30	202-0012	202-1012	202-2012	202-4012	202-5012	9.0mm	40	84	202-0090	202-1090	202-2090	202-4090	202-5090		
1.30mm	8	30	202-0013	202-1013	202-2013	202-4013	202-5013	9.5mm	40	84	202-0095	202-1095	202-2095	202-4095	202-5095		
1.40mm	9	32	202-0014	202-1014	202-2014	202-4014	202-5014	10.0mm	43	89	202-0100	202-1100	202-2100	202-4100	202-5100		
1.50mm	9	32	202-0015	202-1015	202-2015	202-4015	202-5015	10.10mm	43	89	202-0101	202-1101	202-2101	202-4101	202-5101		
1.60mm	10	34	202-0016	202-1016	202-2016	202-4016	202-5016	10.20mm	43	89	202-0102	202-1102	202-2102	202-4102	202-5102		
1.70mm	10	34	202-0017	202-1017	202-2017	202-4017	202-5017	10.30mm	43	89	202-0103	202-1103	202-2103	202-4103	202-5103		
1.80mm	11	36	202-0018	202-1018	202-2018	202-4018	202-5018	10.40mm	43	89	202-0104	202-1104	202-2104	202-4104	202-5104		
1.90mm	11	36	202-0019	202-1019	202-2019	202-4019	202-5019	10.50mm	43	89	202-0105	202-1105	202-2105	202-4105	202-5105		
2.0mm	12	38	202-0020	202-1020	202-2020	202-4020	202-5020	10.60mm	43	89	202-0106	202-1106	202-2106	202-4106	202-5106		
2.1mm	12	38	202-0021	202-1021	202-2021	202-4021	202-5021	10.70mm	47	95	202-0107	202-1107	202-2107	202-4107	202-5107		
2.2mm	13	40	202-0022	202-1022	202-2022	202-4022	202-5022	10.80mm	47	95	202-0108	202-1108	202-2108	202-4108	202-5108		
2.3mm	13	40	202-0023	202-1023	202-2023	202-4023	202-5023	10.90mm	47	95	202-0109	202-1109	202-2109	202-4109	202-5109		
2.4mm	14	43	202-0024	202-1024	202-2024	202-4024	202-5024	11.00mm	47	95	202-0110	202-1110	202-2110	202-4110	202-5110		
2.5mm	14	43	202-0025	202-1025	202-2025	202-4025	202-5025	11.10mm	47	95	202-0111	202-1111	202-2111	202-4111	202-5111		
2.6mm	14	43	202-0026	202-1026	202-2026	202-4026	202-5026	11.20mm	47	95	202-0112	202-1112	202-2112	202-4112	202-5112		
2.7mm	16	46	202-0027	202-1027	202-2027	202-4027	202-5027	11.30mm	47	95	202-0113	202-1113	202-2113	202-4113	202-5113		
2.8mm	16	46	202-0028	202-1028	202-2028	202-4028	202-5028	11.40mm	47	95	202-0114	202-1114	202-2114	202-4114	202-5114		
2.9mm	16	46	202-0029	202-1029	202-2029	202-4029	202-5029	11.50mm	47	95	202-0115	202-1115	202-2115	202-4115	202-5115		
3.0mm	16	46	202-0030	202-1030	202-2030	202-4030	202-5030	11.60mm	47	95	202-0116	202-1116	202-2116	202-4116	202-5116		
3.1mm	18	49	202-0031	202-1031	202-2031	202-4031	202-5031	11.70mm	47	95	202-0117	202-1117	202-2117	202-4117	202-5117		
3.2mm	18	49	202-0032	202-1032	202-2032	202-4032	202-5032	11.80mm	47	95	202-0118	202-1118	202-2118	202-4118	202-5118		
3.3mm	18	49	202-0033	202-1033	202-2033	202-4033	202-5033	11.90mm	51	102	202-0119	202-1119	202-2119	202-4119	202-5119		
3.4mm	20	52	202-0034	202-1034	202-2034	202-4034	202-5034	12.00mm	51	102	202-0120	202-1120	202-2120	202-4120	202-5120		
3.5mm	20	52	202-0035	202-1035	202-2035	202-4035	202-5035	12.10mm	51	102	202-0121	202-1121	202-2121	202-4121	202-5121		
3.6mm	20	52	202-0036	202-1036	202-2036	202-4036	202-5036	12.20mm	51	102	202-0122	202-1122	202-2122	202-4122	202-5122		
3.7mm	20	52	202-0037	202-1037	202-2037	202-4037	202-5037	12.30mm	51	102	202-0123	202-1123	202-2123	202-4123	202-5123		
3.8mm	22	55	202-0038	202-1038	202-2038	202-4038	202-5038	12.40mm	51	102	202-0124	202-1124	202-2124	202-4124	202-5124		
3.9mm	22	55	202-0039	202-1039	202-2039	202-4039	202-5039	12.50mm	51	102	202-0125	202-1125	202-2125	202-4125	202-5125		
4.0mm	22	55	202-0040	202-1040	202-2040	202-4040	202-5040	12.60mm	51	102	202-0126	202-1126	202-2126	202-4126	202-5126		
4.1mm	22	55	202-0041	202-1041	202-2041	202-4041	202-5041	12.70mm	51	102	202-0127	202-1127	202-2127	202-4127	202-5127		
4.2mm	22	55	202-0042	202-1042	202-2042	202-4042	202-5042	12.80mm	51	102	202-0128	202-1128	202-2128	202-4128	202-5128		
4.3mm	24	58	202-0043	202-1043	202-2043	202-4043	202-5043	12.90mm	51	102	202-0129	202-1129	202-2129	202-4129	202-5129		
4.4mm	24	58	202-0044	202-1044	202-2044	202-4044	202-5044	13.00mm	51	102	202-0130	202-1130	202-2130	202-4130	202-5130		
4.5mm	24	58	202-0045	202-1045	202-2045	202-4045	202-5045	13.10mm	51	102	202-0131	202-1131	202-2131	202-4131	202-5131		
4.6mm	24	58	202-0046	202-1046	202-2046	202-4046	202-5046	13.20mm	51	102	202-0132	202-1132	202-2132	202-4132	202-5132		
4.7mm	24	58	202-0047	202-1047	202-2047	202-4047	202-5047	13.30mm	54	107	202-0133	202-1133	202-2133	202-4133	202-5133		
4.8mm	26	62	202-0048	202-1048	202-2048	202-4048	202-5048	13.40mm	54	107	202-0134	202-1134	202-2134	202-4134	202-5134		
4.9mm	26	62	202-0049	202-1049	202-2049	202-4049	202-5049	13.50mm	54	107	202-0135	202-1135	202-2135	202-4135	202-5135		
5.0mm	26	62	202-0050	202-1050	202-2050	202-4050	202-5050	13.60mm	54	107	202-0136	202-1136	202-2136	202-4136	202-5136		
5.1mm	26	62	202-0051	202-1051	202-2051	202-4051	202-5051	13.70mm	54	107	202-0137	202-1137	202-2137	202-4137	202-5137		
5.2mm	26	62	202-0052	202-1052	202-2052	202-4052	202-5052	13.80mm	54	107	202-0138	202-1138	202-2138	202-4138	202-5138		
5.3mm	28	66	202-0053	202-1053	202-2053	202-4053	202-5053	13.90mm	54	107	202-0139	202-1139	202-2139	202-4139	202-5139		
5.4mm	28	66	202-0054	202-1054	202-2054	202-4054	202-5054	14.00mm	54	107	202-0140	202-1140	202-2140	202-4140	202-5140		
5.5mm	28	66	202-0055	202-1055	202-2055	202-4055	202-5055	14.25mm	56	111	202-0142	202-1142	202-2142	202-4142	202-5142		
5.6mm	28	66	202-0056	202-1056	202-2056	202-4056	202-5056	14.50mm	56	111	202-0145	202-1145	202-2145	202-4145	202-5145		
5.7mm	28	66	202-0057	202-1057	202-2057	202-4057	202-5057	14.75mm	56	111	202-0147	202-1147	202-2147	202-4147	202-5147		
5.8mm	28	66	202-0058	202-1058	202-2058	202-4058	202-5058	15.00mm	56	111	202-0150	202-1150	202-2150	202-4150	202-5150		
5.9mm	28	66	202-0059	202-1059	202-2059	202-4059	202-5059	15.25mm	58	115	202-0152	202-1152	202-2152	202-4152	202-5152		
6.0mm	28	66	202-0060	202-1060	202-2060	202-4060	202-5060	15.50mm	58	115	202-0155	202-1155	202-2155	202-4155	202-5155		
6.1mm	31	70	202-0061	202-1061	202-2061	202-4061	202-5061	15.75mm	58	115	202-0157	202-1157	202-2157	202-4157	202-5157		
6.2mm	31	70	202-0062	202-1062	202-2062	202-4062	202-5062	16.00mm	58	115	202-0160	202-1160	202-2160	202-4160	202-5160		
6.3mm	31	70	202-0063	202-1063	202-2063	202-4063	202-5063	16.25mm	60	119	202-0162	202-1162	202-2162	202-4162	202-5162		
6.4mm	31	70	202-0064	202-1064	202-2064	202-4064	202-5064	16.50mm	60	119	202-0165	202-1165	202-2165	202-4165	202-5165		
6.5mm	31	70	202-0065	202-1065	202-2065	202-4065	202-5065	16.75mm	60	119	202-0167	202-1167	202-2167	202-4167	202-5167		
6.6mm	31	70	202-0066	202-1066	202-2066	202-4066	202-5066	17.00mm	60	119	202-0170	202-1170	202-2170	202-4170	202-5170		
6.7mm	31	70	202-0067	202-1067	202-2067	202-4067	202-5067	17.25mm	62	123	202-0172	202-1172	202-2172	202-4172	202-5172		
6.8mm	34	74	202-0068	202-1068	202-2068	202-4068	202-5068	17.50mm	62	123	202-0175	202-1175	202-2175	202-4175	202-5175		
6.9mm	34	74	202-0069	202-1069	202-2069	202-4069	202-5069	17.75mm	62	123	202-0177	202-1177	202-2177	202-4177	202-5177		
7.0mm	34	74	202-0070	202-1070	202-2070	202-4070	202-5070	18.00mm	62	123	202-0180	202-1180	202-2180	202-4180	202-5180		
7.1mm	34	74	202-0071	202-1071	202-2071	202-4071	202-5071	18.25mm	64	127	202-0182	202-1182	202-2182	202-4182	202-5182		
7.2mm	34	74	202-0072	202-1072	202-2072	202-4072	202-5072	18.50mm	64	127	202-0185	202-1185	202-2185	202-4185	202-5185		
7.3mm	34	74	202-0073	202-1073	202-2073	202-4073	202-5073	18.75mm	64	127	202-0187	202-1187	202-2187	202-4187	202-5187		
7.4mm	34	74	202-0074	202-1074	202-2074	202-4074	202-5074	19.00									



Cutting Tools

METRIC TWIST DRILL

High Speed Steel, DIN340



Flute Size	Overall Length	Rolled Black Oxide		Ground Black Oxide			Flute Size	Overall Length	Rolled Black Oxide		Ground Black Oxide				
		Model No.	Model No.	Model No.	Model No.	Model No.			Model No.	Model No.	Model No.	Model No.	Model No.		
1.0mm	33	66	203-0010	203-1010	203-2010	203-3010	203-4010	8.1mm	109	165	203-0081	203-1081	203-2081	203-3081	203-4081
1.1mm	37	60	203-0011	203-1011	203-2011	203-3011	203-4011	8.2mm	109	165	203-0082	203-1082	203-2082	203-3082	203-4082
1.2mm	41	65	203-0012	203-1012	203-2012	203-3012	203-4012	8.3mm	109	165	203-0083	203-1083	203-2083	203-3083	203-4083
1.3mm	41	65	203-0013	203-1013	203-2013	203-3013	203-4013	8.4mm	109	165	203-0084	203-1084	203-2084	203-3084	203-4084
1.4mm	45	70	203-0014	203-1014	203-2014	203-3014	203-4014	8.5mm	109	165	203-0085	203-1085	203-2085	203-3085	203-4085
1.5mm	45	70	203-0015	203-1015	203-2015	203-3015	203-4015	8.6mm	115	175	203-0086	203-1086	203-2086	203-3086	203-4086
1.6mm	50	76	203-0016	203-1016	203-2016	203-3016	203-4016	8.7mm	115	175	203-0087	203-1087	203-2087	203-3087	203-4087
1.7mm	50	76	203-0017	203-1017	203-2017	203-3017	203-4017	8.8mm	115	175	203-0088	203-1088	203-2088	203-3088	203-4088
1.8mm	53	80	203-0018	203-1018	203-2018	203-3018	203-4018	8.9mm	115	175	203-0089	203-1089	203-2089	203-3089	203-4089
1.9mm	53	80	203-0019	203-1019	203-2019	203-3019	203-4019	9.0mm	115	175	203-0090	203-1090	203-2090	203-3090	203-4090
2.0mm	56	85	203-0020	203-1020	203-2020	203-3020	203-4020	9.1mm	115	175	203-0091	203-1091	203-2091	203-3091	203-4091
2.1mm	56	85	203-0021	203-1021	203-2021	203-3021	203-4021	9.2mm	115	175	203-0092	203-1092	203-2092	203-3092	203-4092
2.2mm	56	90	203-0022	203-1022	203-2022	203-3022	203-4022	9.3mm	115	175	203-0093	203-1093	203-2093	203-3093	203-4093
2.3mm	56	90	203-0023	203-1023	203-2023	203-3023	203-4023	9.4mm	115	175	203-0094	203-1094	203-2094	203-3094	203-4094
2.4mm	62	95	203-0024	203-1024	203-2024	203-3024	203-4024	9.5mm	115	175	203-0095	203-1095	203-2095	203-3095	203-4095
2.5mm	62	95	203-0025	203-1025	203-2025	203-3025	203-4025	9.6mm	121	184	203-0096	203-1096	203-2096	203-3096	203-4096
3.0mm	63	100	203-0030	203-1030	203-2030	203-3030	203-4030	9.7mm	121	184	203-0097	203-1097	203-2097	203-3097	203-4097
3.1mm	69	106	203-0031	203-1031	203-2031	203-3031	203-4031	9.8mm	121	184	203-0098	203-1098	203-2098	203-3098	203-4098
3.2mm	69	106	203-0032	203-1032	203-2032	203-3032	203-4032	9.9mm	121	184	203-0099	203-1099	203-2099	203-3099	203-4099
3.3mm	69	106	203-0033	203-1033	203-2033	203-3033	203-4033	10.0mm	121	184	203-0100	203-1100	203-2100	203-3100	203-4100
3.4mm	73	110	203-0034	203-1034	203-2034	203-3034	203-4034	10.5mm	121	184	203-0105	203-1105	203-2105	203-3105	203-4105
3.5mm	73	110	203-0035	203-1035	203-2035	203-3035	203-4035	11.0mm	128	195	203-0110	203-1110	203-2110	203-3110	203-4110
3.6mm	73	110	203-0036	203-1036	203-2036	203-3036	203-4036	11.5mm	128	195	203-0115	203-1115	203-2115	203-3115	203-4115
3.7mm	73	110	203-0037	203-1037	203-2037	203-3037	203-4037	12.0mm	134	205	203-0120	203-1120	203-2120	203-3120	203-4120
3.8mm	78	119	203-0038	203-1038	203-2038	203-3038	203-4038	12.1mm	134	205	203-0121	203-1121	203-2121	203-3121	203-4121
3.9mm	78	119	203-0039	203-1039	203-2039	203-3039	203-4039	12.2mm	134	205	203-0122	203-1122	203-2122	203-3122	203-4122
4.0mm	78	119	203-0040	203-1040	203-2040	203-3040	203-4040	12.3mm	134	205	203-0123	203-1123	203-2123	203-3123	203-4123
4.1mm	78	119	203-0041	203-1041	203-2041	203-3041	203-4041	12.4mm	134	205	203-0124	203-1124	203-2124	203-3124	203-4124
4.2mm	78	119	203-0042	203-1042	203-2042	203-3042	203-4042	12.5mm	134	205	203-0125	203-1125	203-2125	203-3125	203-4125
4.3mm	82	126	203-0043	203-1043	203-2043	203-3043	203-4043	12.6mm	134	205	203-0126	203-1126	203-2126	203-3126	203-4126
4.4mm	82	126	203-0044	203-1044	203-2044	203-3044	203-4044	12.7mm	134	205	203-0127	203-1127	203-2127	203-3127	203-4127
4.5mm	82	126	203-0045	203-1045	203-2045	203-3045	203-4045	12.8mm	134	205	203-0128	203-1128	203-2128	203-3128	203-4128
4.6mm	82	126	203-0046	203-1046	203-2046	203-3046	203-4046	12.9mm	134	205	203-0129	203-1129	203-2129	203-3129	203-4129
4.7mm	82	126	203-0047	203-1047	203-2047	203-3047	203-4047	13.0mm	134	205	203-0130	203-1130	203-2130	203-3130	203-4130
4.8mm	87	132	203-0048	203-1048	203-2048	203-3048	203-4048	13.1mm	134	205	203-0131	203-1131	203-2131	203-3131	203-4131
4.9mm	87	132	203-0049	203-1049	203-2049	203-3049	203-4049	13.2mm	134	205	203-0132	203-1132	203-2132	203-3132	203-4132
5.0mm	87	132	203-0050	203-1050	203-2050	203-3050	203-4050	13.3mm	140	214	203-0133	203-1133	203-2133	203-3133	203-4133
5.1mm	87	132	203-0051	203-1051	203-2051	203-3051	203-4051	13.4mm	140	214	203-0134	203-1134	203-2134	203-3134	203-4134
5.2mm	87	132	203-0052	203-1052	203-2052	203-3052	203-4052	13.5mm	140	214	203-0135	203-1135	203-2135	203-3135	203-4135
5.3mm	87	132	203-0053	203-1053	203-2053	203-3053	203-4053	13.6mm	140	214	203-0136	203-1136	203-2136	203-3136	203-4136
5.4mm	91	139	203-0054	203-1054	203-2054	203-3054	203-4054	13.7mm	140	214	203-0137	203-1137	203-2137	203-3137	203-4137
5.5mm	91	139	203-0055	203-1055	203-2055	203-3055	203-4055	13.8mm	140	214	203-0138	203-1138	203-2138	203-3138	203-4138
5.6mm	91	139	203-0056	203-1056	203-2056	203-3056	203-4056	13.9mm	140	214	203-0139	203-1139	203-2139	203-3139	203-4139
5.7mm	91	139	203-0057	203-1057	203-2057	203-3057	203-4057	14.0mm	140	214	203-0140	203-1140	203-2140	203-3140	203-4140
5.8mm	91	139	203-0058	203-1058	203-2058	203-3058	203-4058	14.25mm	144	220	203-0142	203-1142	203-2142	203-3142	203-4142
5.9mm	91	139	203-0059	203-1059	203-2059	203-3059	203-4059	14.5mm	144	220	203-0145	203-1145	203-2145	203-3145	203-4145
6.0mm	91	139	203-0060	203-1060	203-2060	203-3060	203-4060	14.75mm	144	220	203-0147	203-1147	203-2147	203-3147	203-4147
6.1mm	97	148	203-0061	203-1061	203-2061	203-3061	203-4061	15.0mm	144	220	203-0150	203-1150	203-2150	203-3150	203-4150
6.2mm	97	148	203-0062	203-1062	203-2062	203-3062	203-4062	15.25mm	149	227	203-0152	203-1152	203-2152	203-3152	203-4152
6.3mm	97	148	203-0063	203-1063	203-2063	203-3063	203-4063	15.50mm	149	227	203-0155	203-1155	203-2155	203-3155	203-4155
6.4mm	97	148	203-0064	203-1064	203-2064	203-3064	203-4064	15.75mm	149	227	203-0157	203-1157	203-2157	203-3157	203-4157
6.5mm	97	148	203-0065	203-1065	203-2065	203-3065	203-4065	16.0mm	149	227	203-0160	203-1160	203-2160	203-3160	203-4160
6.6mm	97	148	203-0066	203-1066	203-2066	203-3066	203-4066	16.25mm	154	235	203-0162	203-1162	203-2162	203-3162	203-4162
6.7mm	97	148	203-0067	203-1067	203-2067	203-3067	203-4067	16.5mm	154	235	203-0165	203-1165	203-2165	203-3165	203-4165
6.8mm	102	156	203-0068	203-1068	203-2068	203-3068	203-4068	16.75mm	154	235	203-0167	203-1167	203-2167	203-3167	203-4167
6.9mm	102	156	203-0069	203-1069	203-2069	203-3069	203-4069	17.0mm	154	235	203-0170	203-1170	203-2170	203-3170	203-4170
7.0mm	102	156	203-0070	203-1070	203-2070	203-3070	203-4070	17.25mm	158	241	203-0172	203-1172	203-2172	203-3172	203-4172
7.1mm	102	156	203-0071	203-1071	203-2071	203-3071	203-4071	17.5mm	158	241	203-0175	203-1175	203-2175	203-3175	203-4175
7.2mm	102	156	203-0072	203-1072	203-2072	203-3072	203-4072	17.75mm	158	241	203-0177	203-1177	203-2177	203-3177	203-4177
7.3mm	102	156	203-0073	203-1073	203-2073	203-3073	203-4073	18.0mm	158	241	203-0180	203-1180	203-2180	203-3180	203-4180
7.4mm	102	156	203-0074	203-1074	203-2074	203-3074	203-4074	18.25mm	162	247	203-0182	203-1182	203-2182	203-3182	203-4182
7.5mm	102	156	203-0075	203-1075	203-2075	203-3075	203-4075	18.5mm	162	247	203-0185	203-1185	203-2185	203-3185	203-4185
7.6mm	109	165	203-0076	203-1076	203-2076	203-3076	203-4076	18.75mm	162	247	203-0187	203-1187	203-2187	203-3187	203-4187
7.7mm	109	165	203-0077	203-1077	203-2077	203-3077	203-4077	19.0mm	162	247	203-0190	203-1190	203-2190	203-3190	203-4190
7.8mm	109	165	203-0078	203-1078											