

Hand Tools

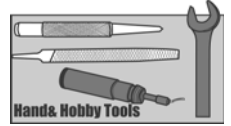

Deburring Tools Sets & Accessories.....	C7-C8
Dividers & Inside and Outside Calipers.....	C2-C3
Files Sets, Screw Extractors.....	C9-C12
Scribers & Sets.....	C1
Stamping Letter & Number Sets, Punches.....	C4-C7
Wrench Socket & Sets.....	C13-C17
Magnetic Lamp, Magnetic Lift and Other Tools.....	C18-C20



STEEL SCRIBERS



One-End Scribers

Model No. 830-2001

Straight, with knurled handle.

Total Length: 175mm



Double-End Scribers

Model No. 830-0386

One straight and one bent point, with knurled handle

Replaceable Point

Total Length: 250mm



Right Angle Scribers

Model No. 830-2006

With hardened point.

Total Length: 8"

HARD-METAL SCRIBERS WITH CARBIDE POINTS



Pocket Type

Model No. 830-2008

Chrome Plated



Heavy Duty Type

Model No. 830-2009

Heavy body, Diameter 8.0mm

Total Length: 180mm



Model No. 830-2010

Metal body, chrome plated.

With 20mm long carbide point

Total Length: 160mm



Replacement Point for 830-0389 Scriber

Model No. 830-0393

Replaceable Point Type

Model No. 830-0389

Aluminum body, With carbide point.

Point Reverses for safety, when not in use.

Replacement point

Total Length: 150mm



HEAVY-DUTY CARBIDE SCRIBER

Model No.830-0500

With carbide point & black,plastic handle,

Total length 150mm

3 PIECE POCKET TOOL SET

Set contains three indispensable tools-carbide point scriber, automatic center punch, plunger release magnet. For scribing, marking, locating and removing chips. Supplied in sturdy and convenient pocket protector case.



Model No.117-3000

TELESCOPIC-POINT SCRIBERS INOX PEN STYLE



Model No. 830-0401

with replaceable carbide point

Model No.830-0405 Replaceable carbide point for 830-0401

Model No.830-0410 Stainless steel shank for 830-0401



Hand Tools

DIVIDER
Rivet Joint Type



Size	Carbon Steel	Stainless Steel
	Model No.	Model No.
100mm/4"	108-0004	109-0004
125mm/5"	108-0005	109-0005
150mm/6"	108-0006	109-0006
175mm/7"	108-0007	109-0007
200mm/8"	108-0008	109-0008
250mm/10"	108-0010	109-0010
300mm/12"	108-0012	109-0012
400mm/16"	108-0016	109-0016
500mm/20"	108-0020	109-0020
600mm/24"	108-0024	109-0024
800mm/32"	108-0032	109-0032
1000mm/40"	108-0040	109-0040

DIVIDER
Adjustable Screw Type



Size	Carbon Steel	Stainless Steel
	Model No.	Model No.
100mm/4"	108-0504	109-0504
125mm/5"	108-0505	109-0505
150mm/6"	108-0506	109-0506
175mm/7"	108-0507	109-0507
200mm/8"	108-0508	109-0508
250mm/10"	108-0510	109-0510
300mm/12"	108-0512	109-0512
400mm/16"	108-0516	109-0516
500mm/20"	108-0520	109-0520
600mm/24"	108-0524	109-0524
800mm/32"	108-0532	109-0532
900mm/36"	108-0536	109-0536
1000mm/40"	108-0540	109-0540

DIVIDER
Rivet Joint Type
with Wing



Size	Carbon Steel	Stainless Steel
	Model No.	Model No.
100mm/4"	108-0104	109-0104
125mm/5"	108-0105	109-0105
150mm/6"	108-0106	109-0106
175mm/7"	108-0107	109-0107
200mm/8"	108-0108	109-0108
250mm/10"	108-0110	109-0110
300mm/12"	108-0112	109-0112
400mm/16"	108-0116	109-0116
500mm/20"	108-0120	109-0120
600mm/24"	108-0124	109-0124
800mm/32"	108-0132	109-0132
900mm/36"	108-0136	109-0136
1000mm/40"	108-0140	109-0140

DIVIDER
Adjustable Screw Type
with Wing



Size	Carbon Steel	Stainless Steel
	Model No.	Model No.
100mm/4"	108-0604	109-0604
125mm/5"	108-0605	109-0605
150mm/6"	108-0606	109-0606
175mm/7"	108-0607	109-0607
200mm/8"	108-0608	109-0608
250mm/10"	108-0610	109-0610
300mm/12"	108-0612	109-0612
400mm/16"	108-0616	109-0616
500mm/20"	108-0620	109-0620
600mm/24"	108-0624	109-0624
800mm/32"	108-0632	109-0632
900mm/36"	108-0636	109-0636
1000mm/40"	108-0640	109-0640

DIVIDER
Rivet Joint Type
with Wing and
Pencil Holder



Size	Carbon Steel	Stainless Steel
	Model No.	Model No.
100mm/4"	108-0204	109-0204
125mm/5"	108-0205	109-0205
150mm/6"	108-0206	109-0206
175mm/7"	108-0207	109-0207
200mm/8"	108-0208	109-0208
250mm/10"	108-0210	109-0210
300mm/12"	108-0212	109-0212
400mm/16"	108-0216	109-0216
500mm/20"	108-0220	109-0220
600mm/24"	108-0224	109-0224
800mm/32"	108-0232	109-0232
1000mm/40"	108-0240	109-0240

DIVIDER
Spring Type



Size	SPRING Carbon Steel	SPRING Stainless Steel
	Model No.	Model No.
75mm/3"	108-0903	109-0903
100mm/4"	108-0904	109-0904
125mm/5"	108-0905	109-0905
150mm/6"	108-0906	109-0906
175mm/7"	108-0907	109-0907
200mm/8"	108-0908	109-0908
250mm/10"	108-0910	109-0910
300mm/12"	108-0912	109-0912
400mm/16"	108-0916	109-0916
500mm/20"	108-0920	109-0920
600mm/24"	108-0924	109-0924

WWW.PRECOTOOLS.CN



INSIDE CALIPER

Rivet Joint Type



Size	Carbon Steel	Stainless Steel
	Model No.	Model No.
100mm/4"	108-0304	109-0304
125mm/5"	108-0305	109-0305
150mm/6"	108-0306	109-0306
175mm/7"	108-0307	109-0307
200mm/8"	108-0308	109-0308
250mm/10"	108-0310	109-0310
300mm/12"	108-0312	109-0312
400mm/16"	108-0316	109-0316
500mm/20"	108-0320	109-0320
600mm/24"	108-0324	109-0324
800mm/32"	108-0332	109-0332
900mm/36"	108-0336	109-0336
1000mm/40"	108-0340	109-0340

INSIDE CALIPER

Adjustable Screw Type



Size	Carbon Steel	Stainless Steel
	Model No.	Model No.
100mm/4"	108-0704	109-0704
125mm/5"	108-0705	109-0705
150mm/6"	108-0706	109-0706
175mm/7"	108-0707	109-0707
200mm/8"	108-0708	109-0708
250mm/10"	108-0710	109-0710
300mm/12"	108-0712	109-0712
400mm/16"	108-0716	109-0716
500mm/20"	108-0720	109-0720
600mm/24"	108-0724	109-0724
800mm/32"	108-0732	109-0732
900mm/36"	108-0736	109-0736
1000mm/40"	108-0740	109-0740

INSIDE CALIPER

Spring Type



Size	Carbon Steel	Stainless Steel
	Model No.	Model No.
75mm/3"	108-1003	109-1003
100mm/4"	108-1004	109-1004
125mm/5"	108-1005	109-1005
150mm/6"	108-1006	109-1006
175mm/7"	108-1007	109-1007
200mm/8"	108-1008	109-1008
250mm/10"	108-1010	109-1010
300mm/12"	108-1012	109-1012
400mm/16"	108-1016	109-1016
500mm/20"	108-1020	109-1020
600mm/24"	108-1024	109-1024

OUTSIDE CALIPER

Spring Type



Size	Carbon Steel	Stainless Steel
	Model No.	Model No.
75mm/3"	108-1103	109-1103
100mm/4"	108-1104	109-1104
125mm/5"	108-1105	109-1105
150mm/6"	108-1106	109-1106
175mm/7"	108-1107	109-1107
200mm/8"	108-1108	109-1108
250mm/10"	108-1110	109-1110
300mm/12"	108-1112	109-1112
400mm/16"	108-1116	109-1116
500mm/20"	108-1120	109-1120
600mm/24"	108-1124	109-1124

OUTSIDE CALIPER

Rivet Joint Type



Size	Carbon Steel	Stainless Steel
	Model No.	Model No.
100mm/4"	108-0404	109-0404
125mm/5"	108-0405	109-0405
150mm/6"	108-0406	109-0406
175mm/7"	108-0407	109-0407
200mm/8"	108-0408	109-0408
250mm/10"	108-0410	109-0410
300mm/12"	108-0412	109-0412
400mm/16"	108-0416	109-0416
500mm/20"	108-0420	109-0420
600mm/24"	108-0424	109-0424
800mm/32"	108-0432	109-0432
900mm/36"	108-0436	109-0436
1000mm/40"	108-0440	109-0440

OUTSIDE CALIPER

Adjustable Screw Type



Size	Carbon Steel	Stainless Steel
	Model No.	Model No.
100mm/4"	108-0804	109-0804
125mm/5"	108-0805	109-0805
150mm/6"	108-0806	109-0806
175mm/7"	108-0807	109-0807
200mm/8"	108-0808	109-0808
250mm/10"	108-0810	109-0810
300mm/12"	108-0812	109-0812
400mm/16"	108-0816	109-0816
500mm/20"	108-0820	109-0820
600mm/24"	108-0824	109-0824
800mm/32"	108-0832	109-0832
900mm/36"	108-0836	109-0836
1000mm/40"	108-0840	109-0840

INSIDE & OUTSIDE CALIPER



Size	Carbon Steel	Stainless Steel
	Model No.	Model No.
150mm/6"	108-2006	109-2006
175mm/7"	108-2007	109-2007
200mm/8"	108-2008	109-2008
250mm/10"	108-2010	109-2010
300mm/12"	108-2012	109-2012

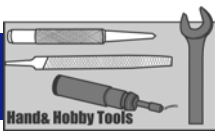

Hand Tools

STEEL STAMPING LETTER & NUMBER SETS

Heat Treatment 50-55 HRC,
Alloy Steel



Specification	Model No.
1/16" A to Z 27 -piece per set	835-1000
1/8" A to Z 27 -piece per set	835-1005
3/16" A to Z 27 -piece per set	835-1010
1/4" A to Z 27 -piece per set	835-1015
1/16" 0-9 9 -piece per set	835-1055
1/8" 0-9 9 -piece per set	835-1060
3/16" 0-9 9 -piece per set	835-1065
1/4" 0-9 9-piece per set	835-1070
1/16" A to Z & 0-9 36 -piece per set	835-2000
1/8" A to Z & 0-9 36 -piece per set	835-2001
3/16" A to Z & 0-9 36 -piece per set	835-2002
1/4" A to Z & 0-9 36 -piece per set	835-2003

Size	Specification	Model No.
1mm	A-Z 27 pcs	835-3001
	0-9 9 pcs	835-3002
	A-Z & 0-9 36pcs	835-3005
1.5mm	A-Z 27 pcs	835-3011
	0-9 9 pcs	835-3012
	A-Z & 0-9 36pcs	835-3015
2mm	A-Z 27 pcs	835-3021
	0-9 9 pcs	835-3022
	A-Z & 0-9 36pcs	835-3025
3mm	A-Z 27 pcs	835-3031
	0-9 9 pcs	835-3032
	A-Z & 0-9 36pcs	835-3035
4mm	A-Z 27 pcs	835-3041
	0-9 9 pcs	835-3042
	A-Z & 0-9 36pcs	835-3045
5mm	A-Z 27 pcs	835-3051
	0-9 9 pcs	835-3052
	A-Z & 0-9 36pcs	835-3055
6mm	A-Z 27 pcs	835-3061
	0-9 9 pcs	835-3062
	A-Z & 0-9 36pcs	835-3065
8mm	A-Z 27 pcs	835-3081
	0-9 9 pcs	835-3082
	A-Z & 0-9 36pcs	835-3085
10mm	A-Z 27 pcs	835-3101
	0-9 9 pcs	835-3102
	A-Z & 0-9 36pcs	835-3105
12mm	A-Z 27 pcs	835-3121
	0-9 9 pcs	835-3122
	A-Z & 0-9 36pcs	835-3125

POWER PUNCH I.D.

SET MAKES 38 PCS/SET



- Permanently identifies your belongings.
- Imprints Wood
- Imprints Metal
- Steel Handle 6 x 5/8"

Complete set includes both letters and numbers plus a 6" hammer style.

Description	Model No.
Handle + No. 835-2000 1/16" Letter Punches	830-8350
Handle + No. 835-2001 1/18" Letter Punches	830-8351
Handle + No. 835-2002 3/16" Letter Punches	830-8352
Handle + No. 835-2003 1/4" Letter Punches	830-8353

112-PC. INTERCHANGEABLE STEEL TYPE KITS

For Hand or Machine Use, Special Tool Steel



- A fast easy solution for multi-character marking. Now in a simple stroke you can indent a series of letters and numbers in a product or nameplate. These kits are made of special tool steel. Each character is hardened and tempered to 59-61 Rockwell C and nickel finished to resist rust.
- Each kit is packed in a case and contains: Type Holder with a complete selection of letters, numbers, dash, slash, amok, period, comma, ampersand and spacers.

Sets consist of the following

Size	Model No.
1/16"	829-1800
3/32"	829-1801
1/8"	829-1802
3/16"	829-1803
1/4"	829-1804
3/8"	829-1805

A	A	A	B	B	C	C	D	D	E
E	E	E	F	F	G	G	H	H	I
I	I	J	J	K	K	L	L	L	M
M	N	N	N	O	O	O	P	P	Q
R	R	R	S	S	S	T	T	U	U
U	V	W	W	X	X	Y	Z	&	/
/	-	-	.	.	.	1	1	1	1
1	2	2	2	2	3	3	3	4	4
4	4	5	5	5	6	6	6	7	7
7	8	8	8	9	9	9	0	0	0



STEEL TYPE & HOLDERS

- Stamp a series of letters or figures in a producing nameplate or metal part, with uniform legibility, in one stroke!
- Hand mobile type holders include threaded pin, Allen wrench and screw.
- Blanks must be used for spacing - or filling unused capacity of type holder.

Steel Type Holder

(1/8" Wide, 1/4" High, 1" Long)

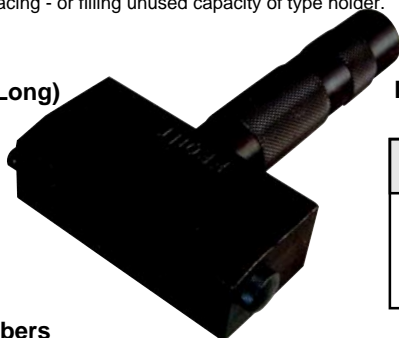

Height	Capability	Model No.
1/8"	8	830-0900
1/8"	12	830-0905
1/4"	8	830-0910
1/4"	12	830-0915

Individual Steel Type Sets

Character Width	Description	Model No.
1/8"	Letter A-Z	830-1027
1/8"	Number 0-9	830-1510
1/4"	Letter A-Z	830-1131
1/4"	Number 0-9	830-1610

Steel Blanks

Size	Model No.
1/8"	830-1135
1/4"	830-1145

Individual Letters & Numbers

Character	1/8" Model No.	1/4" Model No.	Character	1/8" Model No.	1/4" Model No.	Character	1/8" Model No.	1/4" Model No.
A	830-1001	830-1101	M	830-1013	830-1113	Y	830-1025	830-1125
B	830-1002	830-1102	N	830-1014	830-1114	Z	830-1026	830-1126
C	830-1003	830-1103	O	830-1015	830-1115	0	830-1500	830-1600
D	830-1004	830-1104	P	830-1016	830-1116	1	830-1501	830-1601
E	830-1005	830-1105	Q	830-1017	830-1117	2	830-1502	830-1602
F	830-1006	830-1106	R	830-1018	830-1118	3	830-1503	830-1603
G	830-1007	830-1107	S	830-1019	830-1119	4	830-1504	830-1604
H	830-1008	830-1108	T	830-1020	830-1120	5	830-1505	830-1605
I	830-1009	830-1109	U	830-1021	830-1121	6	830-1506	830-1606
J	830-1010	830-1110	V	830-1022	830-1122	7	830-1507	830-1607
K	830-1011	830-1111	W	830-1023	830-1123	8	830-1508	830-1608
L	830-1012	830-1112	X	830-1024	830-1124	9	830-1509	830-1609

AUTOMATIC CENTER PUNCHES

Features:

- Moveable components are made from tool steel and hardened. The point is easily removed for sharpening.
- The pressure of marking is controlled by ratching the dunned cap. Screw the cap down for heavy indentations and screw the cap upward for lighter markings
- Automatic Heavy Duty Center Punch..
- Handle Length 6", Handle Diameter 5/8"



Model No. 830-3001 steel Handle
Model No. 830-3002 copper Handle

UNIVERSAL TRANSFER PUNCHES & ALIGNERS

- Precision ground and spring loaded.
- All parts made from steel & hardened.
- Centers top of 3/16"-3/4" hole
- Replaces different size transfer punches.
- Perfect hole center alignment assured.

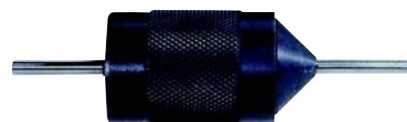
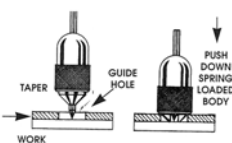

Specification	Weight (lbs)	Model No.
3/16" Dia. Punch 3-1/8" L for 1/4"-3/4" hole	0.26	830-0150
3/16" Dia. Punch 4-1/8" L for 1/4"-1-1/16" hole	0.46	830-0180



CENTER PUNCHES

Individual Punches

Inch 5 Piece Punch Set Model No. 830-0200, includes all about five sizes.

Inch 3 Piece Punch set Model No. 830-0210, includes 1/16", 5/64", 3/32" punches.

Metric 5-pc punch set Model No. 830-0220, includes all about five sizes.

Metric 3-pc punch set Model No. 830-0230, includes 1.6mm, 2.0mm, 2.4mm punches.

Inch	
Point Dia.	Model No.
1/16"	830-0201
5/64"	830-0202
3/32"	830-0203
9/64"	830-0204
5/32"	830-0205

Metric	
Point Dia.	Model No.
1.6mm	830-0211
2.0mm	830-0212
2.4mm	830-0213
3.6mm	830-0214
4.0mm	830-0215

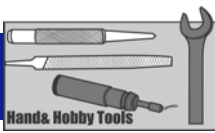

Hand Tools



EXTRA LONG DRIVE PIN PUNCHES

Inch 5 Piece Set Model No. 830-0240

Sets Includes: 1/8", 3/16", 1/4", 5/16", 3/8".

Overall length of 8". Complete with vinyl pouch.

Metric 5 Piece Set Model No. 830-0270

Sets Includes: 3.2mm

4.8 mm, 6.4mm, 8.0mm, 9.5mm. Overall length of 200mm. Complete with vinyl pouch.

Individual Punches

Inch		Metric	
Point Dia.	Model No.	Point Dia.	Model No.
1/8"	830-0242	3.2mm	830-0272
3/16"	830-0244	4.8mm	830-0274
1/4"	830-0246	6.4mm	830-0276
5/16"	830-0248	8.0mm	830-0278
3/8"	830-0250	9.5mm	830-0280

DRIVE PIN PUNCH SETS



Inch			Metric		
Description	Pcs.	Model No.	Description	Pcs.	Model No.
1/16, 3/32, 1/8, 5/32"	4Pcs	830-0260	1.6, 2.4, 3.2, 4 mm	4Pcs	830-0290
3/16, 7/32, 1/4, 5/16"	4Pcs	830-0262	4.8, 5.6, 6.4, 8.0mm	4Pcs	830-0292
1/16, 3/32, 1/8, 5/32, 3/16, 7/32, 1/4, 5/16"	8Pcs	830-0264	1.6, 2.4, 3.2, 4 mm	8Pcs	830-0294
			4.8, 5.6, 6.4, 8.0mm		

TRANSFER PUNCHES & SETS

Features:

- Heat treated and tempered for long life.
- Diameters 0.0025 undersize to facilitate use.
- Black oxide finish.

Sets 28pcs/set Punches includes:

4-7/8" long with indexed stand.

Size: 3/32" - 1/2" by 64ths, plus handy 17/32" size.



Description	Steel Stand Model No.	Plastic Stand Model No.
25pcs 1mm to 13mm by 0.5mm	830-4025	830-4125
26pcs letters a-z	830-4026	830-4126
28pcs 3/32" to 1/2" by 64ths plus 7/32"	830-4028	830-4128
33pcs 1/2" to 1" by 64ths	830-4033	-----
60pcs numbers 1 to 60	830-4060	830-4160

Individual Punches

Size	Model No.	Size	Model No.	Size	Model No.	Size	Model No.	Size	Model No.	Size	Model No.
3/32"	830-0106	11/64"	830-0111	1/4"	830-0116	21/64"	830-0121	13/32"	830-0126	31/64"	830-0131
7/64"	830-0107	3/16"	830-0112	17/64"	830-0117	11/32"	830-0122	27/64"	830-0127	1/2"	830-0132
1/8"	830-0108	13/64"	830-0113	9/32"	830-0118	23/64"	830-0123	7/16"	830-0128	33/64"	830-0133
9/64"	830-0109	7/32"	830-0114	19/64"	830-0119	3/8"	830-0124	29/64"	830-0129	17/32"	830-0134
5/32"	830-0110	15/64"	830-0115	5/16"	830-0120	25/64"	830-0125	15/32"	830-0130		

7-PIECE TRANSFER SCREW SETS

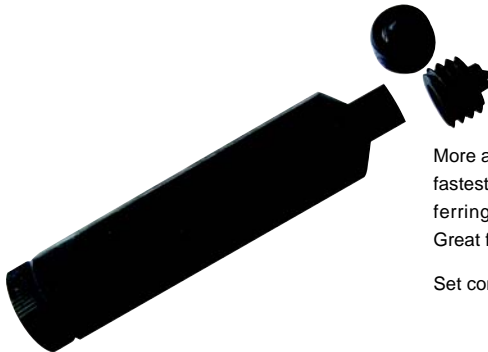

More accurate than transfer punches. The fastest and most precise method of transferring threaded holes to mating parts. Great for tool and die work and in lay out.

Set consist of 1 handle and 6 screws.

Size	Pitch	NC		NF	
		Pitch	Model No.	Pitch	Model No.
4	40		830-3014	48	830-3114
5	40		830-3015	44	830-3115
6	32		830-3016	40	830-3116
8	32		830-3018	36	830-3118
10	24		830-3020	32	830-3120
3/16	24		830-3021	32	830-3121
12	24		830-3022	28	830-3122
1/4	20		830-3023	28	830-3123
5/16	18		830-3024	24	830-3124
3/8	16		830-3025	24	830-3125
7/16	14		830-3026	20	830-3126
1/2	13		830-3027	20	830-3127
9/16	12		830-3028	18	830-3128
5/8	11		830-3029	18	830-3129
3/4	10		830-3030	16	830-3130
7/8	9		830-3031	14	830-3131
1	8		830-3032	14	830-3132



HOLLOW PUNCH SET

The fast, easy way to punch accurate holes in gasket material, light gauge sheet metal, vinyl, leather, and more. High carbon construction with precision ground flutes and cutting edges. Easy to grip knurled shank.



6 piece set includes 3/16, 1/4, 5/16, 3/8, 7/16, 1/2 punches
Model No. 830-8006

16 PIECE PUNCH & CHISEL SET

- Comes in a vinyl roll-up pouch.
- 4 starting punches: 9-3/4", 7-3/4", 5-3/4", 5-13/16".
- 5 cold chisels: 8x5/8, 7x3/4, 6-3/4x5/8, 5-3/4x1/2, 5-3/4x3/8".
- 1 center punch.
- 3 pin punches.
- 1 prick punch.
- 1 diamond point punch.



Model No. 830-8016

24 PIECE PIN PUNCH SET



This set combines all the most used pin punches, all are forge hardened, heat-treated tool steel, Includes:

- 5 piece 8" extra long drive pin punches.
- 8 piece 4" long drive pin punches.
- 5 piece round shank center punches.
- 3 piece 5/32" taper pin punches.
- 1 handle for pin punches.
- 1 piece 6"/150mm ruler.
- 1 piece 4" divider.

Model No. 830-0024

15 PIECE GASKET PUNCH SET



Punch quick, accurate washers and gaskets on the job. Use on rubber, leather, copper, soft brass, and other materials.

Size: 1-1/2, 1-3/8, 1-1/4, 1-1/8, 1, 7/8, 3/4, 5/8, 1/2, 7/16, 3/8, 5/16, and 1/4"

Model No. 830-2115

BLIND- HOLE SPOTTER

Fast, easy way to locate opposite centers. When holes do not extend through material (such as holes for dowel pins, perforating punches, etc.) Spellmaco blind-hole spotters get the job done simply. Correct size spotter can be used in threaded, drilled or reamed holes. Packaged six of one size in plastic tube.



Model No.830-5300 108pcs/set 1/8-21/32" by 32nds. 6pc each.

Model No.830-5305 66pcs/set 11/16-1" By 32nds. 6pc each

Size	Model No.	Size	Model No.	Size	Model No.	Size	Model No.
1/8"	830-5008	13/32"	830-5026	11/16"	830-5044	31/32"	830-5062
9/64"	830-5009	27/64"	830-5027	45/64"	830-5045	63/64"	830-5063
5/32"	830-5010	7/16"	830-5028	23/32"	830-5046	1"	830-5064
11/64"	830-5011	29/64"	830-5029	47/64"	830-5047	3#	830-5103
3/16"	830-5012	15/32"	830-5030	3/4"	830-5048	6#	830-5106
13/64"	830-5013	31/64"	830-5031	49/64"	830-5049	7#	830-5107
7/32"	830-5014	1/2"	830-5032	25/32"	830-5050	8#	830-5108
15/64"	830-5015	33/64"	830-5033	51/64"	830-5051	10#	830-5110
1/4"	830-5016	17/32"	830-5034	13/16"	830-5052	16#	830-5116
17/64"	830-5017	35/64"	830-5035	53/64"	830-5053	20#	830-5120
9/32"	830-5018	9/16"	830-5036	27/32"	830-5054	21#	830-5121
19/64"	830-5019	37/64"	830-5037	55/64"	830-5055	25#	830-5125
5/16"	830-5020	19/32"	830-5038	7/8"	830-5056	29#	830-5129
21/64"	830-5021	39/64"	830-5039	57/64"	830-5057	30#	830-5130
11/32"	830-5022	830-5040	29/64"	830-5058		F	830-5206
23/64"	830-5023	41/64"	830-5041	59/64"	830-5059	I	830-5209
3/8"	830-5024	21/32"	830-5042	15/16"	830-5060	P	830-5216
25/64"	830-5025	43/64"	830-5043	61/64"	830-5061	Q	830-5217

DOUBLE DEBURRER WITH HSS DISK BLADE



Model No. 380-0060



Blade

Model No. 380-0061

- Plastic handle with hand protector and 2 HSS blades.
- Exchangeable HSS disk Blades
- The disk Blades can be turned when the cutting surfaces become worn, enabling the whole blade circumference to be utilized.
- The distance between the disk blades can be adjusted.
- Suitable for double-sided deburring of steel, aluminum, brass, copper and plastic sheets up to 10mm thick.









6 PIECE DEBURRING TOOLS SET

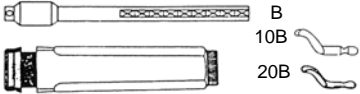
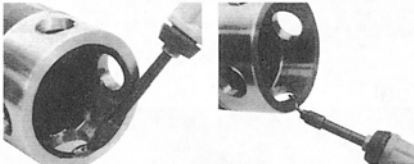
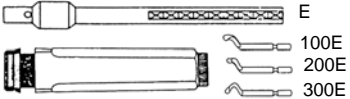
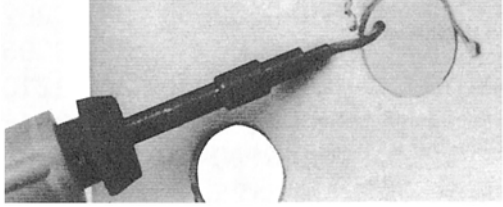
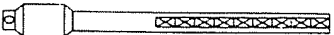

Includes: flat diamond coated file, triangular scraper, flat scraper, round scraper, swivel blade tool, rotational deburring tool with minimum hole diameter 0.08"

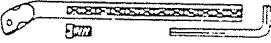
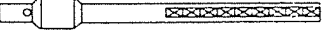
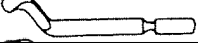
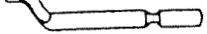
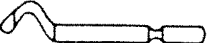
Model No.380-0160

DEBURRING TOOLS & BLADES

<p>Description</p> <p>All steel holders fit in this handle which is adjustable by a knurled ring up to 100mm and can be fixed in any position. The replacement blades fit in the end of the detachable handle.</p>	<p>Model No.</p> <p>380-0010</p> <p>plastic handle only</p>	
<p>Deburring Set "B", 4 Parts</p> 	<p>380-0003</p>	
<p>Deburring Set "E", 5 Parts</p> 	<p>380-0006</p>	
<p>Holder B</p>	<p>380-0011</p>	<p>Holder B</p> 
<p>The mostly used blade for inner and outer Deburring</p>	<p>380-0012</p>	<p>Blade 10B</p> 
<p>HSS blade for brass and cast iron, can be used on both directions</p>	<p>380-0014</p>	<p>Blade 20B</p> 
<p>HSS blade for deburring thin gauge materials inner and outer.</p>	<p>380-0015</p>	<p>Blade 30B</p> 
<p>Holder C</p>	<p>380-0019</p>	<p>Holder C</p> 
<p>Holder D</p>	<p>380-0022</p>	<p>Holder D</p> 
<p>Holder E</p>	<p>380-0025</p>	<p>Holder E</p> 
<p>For steel and aluminum</p>	<p>380-0026</p>	<p>Blade 100E</p> 
<p>For brass and cast iron</p>	<p>380-0027</p>	<p>Blade 200E</p> 
<p>For deburring from two sides</p>	<p>380-0028</p>	<p>Blade 300E</p> 
<p>Holder F</p>	<p>380-0031</p>	<p>Holder F</p> 
<p>Throw away deburring tool with blade 100E, blade not replaceable.</p>	<p>380-0052</p>	
<p>Three 380-0052 deburring tool set</p>	<p>380-0352</p>	
<p>Throw away deburring tool with blade 100E</p>	<p>380-0054</p>	

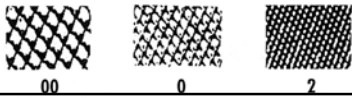

SWISS PATTERN FILES

Industrial grade

Pillar Files



- Similar in shape to Hand Files but only two-thirds as wide.
- Double cut on two sides only.

Length	Approx.		Cut No. 00	Cut No. 0	Cut No. 2
	Width		Model No.	Model No.	Model No.
4"	3/8 x 7/64"		511-0004	511-0104	511-0204
6"	1/2 x 9/64"		511-0006	511-0106	511-0206
8"	39/64 x 13/64"		511-0008	511-0108	511-0208

Pillar Narrow & Extra Narrow Files



- Similar in shape to Hand Files but only two-thirds as wide.
- Double cut on two sides only.
- Edges are safe.

Length	Approx.		Cut No. 00	Cut No. 0	Cut No. 2
	Width		Model No.	Model No.	Model No.
6"	23/64 x 9/64"		511-1006	511-1106	511-1206
8"	29/64 x 13/64"		511-1008	511-1108	511-1208
8"	1/4 x 5/32"		511-1018	511-1118	511-1218

Half Round Files



- Taper in thickness and width to a point.
- Double cut on both flat and half round sides

Length	Approx.		Cut No. 00	Cut No. 0	Cut No. 2
	Width		Model No.	Model No.	Model No.
4"	11/32 x 1/8"		511-2004	511-2104	511-2204
6"	17/32 x 9/64"		511-2006	511-2106	511-2206
8"	45/64 x 3/64"		511-2008	511-2108	511-2208

Round Files



- Taper throughout length to a fine point.
- Double cut .

Length	Approx.		Cut No. 00	Cut No. 0	Cut No. 2
	Width		Model No.	Model No.	Model No.
4"	1/8"		511-3004	511-3104	511-3204
6"	3/16"		511-3006	511-3106	511-3206
8"	1/4"		511-3008	511-3108	511-3208

Hand Files



- Parallel in width but taper in thickness
- Sides are double cut.
- Single cut on one edge, safe cut on other edge.

Length	Approx.		Cut No. 00	Cut No. 0	Cut No. 2
	Width		Model No.	Model No.	Model No.
4"	17/32 x 1/8"		511-4004	511-4104	511-4204
6"	3/4 x 5/32"		511-4006	511-4106	511-4206

Warding Files



- Rectangular in cross section with thickness approx. One-eighth their eighth.
- Taper slightly in thickness and to a point in width.
- Double cut on flat sides & single on edges.

Length	Approx.		Cut No. 00	Cut No. 0	Cut No. 2
	Width		Model No.	Model No.	Model No.
4"	17/32 x 3/64"		511-5004	511-5104	511-5204
6"	5/16 x 5/64"		511-5006	511-5106	511-5206

Three square Files



- A triangular section with 60° angles.
- Gradually tapered on all sides to fine point.
- Ideal for filing corners and edges in extrusion dies where sharp edges must be held.

Length	Approx.		Cut No. 00	Cut No. 0	Cut No. 2
	Width		Model No.	Model No.	Model No.
4"	9/32"		511-6004	511-6104	511-6204
6"	3/4 x 3/8" 5/32"		511-6006	511-6106	511-6206

Knife Files



- Tapered in width and thickness .
- Same thickness from point to shoulder at the knife edge.
- Approx 10° included angle of sharp edge.
- Ideal for filing in a slot, wedge shape opening, or restricted area.

Length	Approx.		Cut No. 00	Cut No. 0	Cut No. 2
	Width		Model No.	Model No.	Model No.
4"	15/32x1/8"		511-7004	511-7104	511-7204
6"	23/32x5/32"		511-7006	511-7106	511-7206



Hand Tools



BASTARD



SECOND CUT



SMOOTH

AMERICAN PATTERN FILES

Industrial Grade

Three square files



- Machinist's Files.
- Triangular in cross-section, double-cut, have fairly sharp corners.
- For filing internal angles.
- More acute than the right angle for clearing out square corners.

Length	Approx.		Bastard Cut	Second Cut	Smooth Cut
	Width		Model No.	Model No	Model No.
4"	11/32"		510-6004	510-6104	510-6204
6"	15/32"		510-6006	510-6106	510-6206
8"	5/8"		510-6008	510-6108	510-6208
10"	3/4"		510-6010	510-6110	510-6210
12"	27/32"		510-6012	510-6112	510-6212
14"	15/156"		510-6014	510-6114	510-6214

Warding files



- Rectangular in section and used principally by locksmiths in repairing or in filing ward notches in keys.
- Also suitable for use in narrow spaces where other files will not fit. All double cut on sides, single cut on edges.

Length	Approx.		Bastard Cut	Second Cut	Smooth Cut
	Width		Model No.	Model No	Model No.
4"	15/32 x 3/64"		510-8004	510-8104	510-8204
6"	5/8 x 5/64"		510-8006	510-8106	510-8206
8"	25/32 x 3/32"		510-8008	510-8108	510-8208
10"	15/16 x 1/8"		510-8010	510-8110	510-8210
12"	1-3/32 x 5/32"		510-8012	510-8112	510-8212
14"	1-1/4 x 3/16"		510-8014	510-8114	510-8214

Knife files



- Double cut.
- Used in getting through very small.
- Crevices, slots, keyways, etc.
- Generally used by tool and die makers on work having acute angles

Length	Approx.		Bastard Cut	Second Cut	Smooth Cut
	Width		Model No.	Model No	Model No.
4"	15/32 x 7/64"		510-0004	510-0104	510-0204
6"	21/32 x 5/32"		510-0006	510-0106	510-0206
8"	27/32 x 3/16"		510-0008	510-0108	510-0208
10"	1-1/32 x 1/4"		510-0010	510-0110	510-0210

Flat files



- Rectangular cross-section.
- Double cut teeth.
- Slight taper.
- Cut on both sides.
- Used wherever metal must be removed rapidly.

Length	Approx.		Bastard Cut	Second Cut	Smooth Cut
	Width		Model No.	Model No	Model No.
4"	7/16 x 1/8"		510-1004	510-1104	510-1204
6"	19/32 x 5/32"		510-1006	510-1106	510-1206
8"	3/4 x 7/32"		510-1008	510-1108	510-1208
10"	15/16 x 9/32"		510-1010	510-1110	510-1210
12"	1-1/8 x 11/32"		510-1012	510-1112	510-1212
14"	1-9/32 x 13/32"		510-1014	510-1114	510-1214
16"	1-15/32 x 15/32"		510-1016	510-1116	510-1216

Half round files



- The cross-section is rounded on one side and flat on the other.
- Allows the file to be used effectively on convex and concave surfaces.
- Tapered towards the points in width and thickness.

Length	Approx.		Bastard Cut	Second Cut	Smooth Cut
	Width		Model No.	Model No	Model No.
4"	7/16 x 1/8"		510-2004	510-2104	510-2204
6"	19/32 x 5/32"		510-2006	510-2106	510-2206
8"	3/4 x 7/32"		510-2008	510-2108	510-2208
10"	15/16 x 9/32"		510-2010	510-2110	510-2210
12"	1-1/8 x 11/32"		510-2012	510-2112	510-2212
14"	1-9/32 x 13/32"		510-2014	510-2114	510-2214
16"	1-15/32 x 15/32"		510-2016	510-2116	510-2216

Round files



- Machinist's file.
- Circular in cross-section.
- Use to file circular openings or concave surfaces.
- Bastard cut 6" and longer, second cut files 12" and longer are double cut. All others are single cut.

Length	Approx.		Bastard Cut	Second Cut	Smooth Cut
	Width		Model No.	Model No	Model No.
4"	5/32"		510-4004	510-4104	510-4204
6"	1/4"		510-4006	510-4106	510-4206
8"	5/16"		510-4008	510-4108	510-4208
10"	3/8"		510-4010	510-4110	510-4210
12"	1/2"		510-4012	510-4112	510-4212
14"	5/8"		510-4014	510-4114	510-4214

Square files



- Square in cross-section.
- Used principally for filing slots, keyways.
- General surface filing.
- Double cut.

Length	Approx.		Bastard Cut	Second Cut	Smooth Cut
	Width		Model No.	Model No	Model No.
4"	5/32"		510-5004	510-5104	510-5204
6"	1/4"		510-5006	510-5106	510-5206
8"	5/16"		510-5008	510-5108	510-5208
10"	3/8"		510-5010	510-5110	510-5210
12"	1/2"		510-5012	510-5112	510-5212
14"	5/8"		510-5014	510-5114	510-5214



SWISS PATTER KNURLED ROUND HANDLE NEEDLE FILES



INDIVIDUAL FILES

Type	Overall Length	Length Of Cut	Cut No. 0 Model No.	Cut No. 1 Model No.	Cut No. 2 Model No.
Round	4"	2"	382-0401	382-0421	382-0431
Round	5-1/2"	2-1/2"	382-0501	382-0521	382-0531
Round	6-1/4"	3"	382-0601	382-0621	382-0631
Half Round	4"	2"	382-0402	382-0422	382-0462
Half Round	5-1/2"	2-1/2"	382-0502	382-0522	382-0562
Half Round	6-1/4"	3"	382-0602	382-0622	382-0632
Square	4"	2"	382-0403	382-0423	382-0433
Square	5-1/2"	2-1/2"	382-0503	382-0523	382-0533
Square	6-1/4"	3"	382-0603	382-0623	382-0633
Three Square	4"	2"	382-0404	382-0424	382-0434
Three Square	5-1/2"	2-1/2"	382-0504	382-0524	382-0534
Three Square	6-1/4"	3"	382-0604	382-0624	382-0634
Knife	4"	2"	382-0405	382-0425	382-0435
Knife	5-1/2"	2-1/2"	382-0505	382-0525	382-0535
Knife	6-1/4"	3"	382-0605	382-0625	382-0635
Flat	4"	2"	382-0406	382-0426	382-0436
Flat	5-1/2"	2-1/2"	382-0506	382-0526	382-0536
Flat	6-1/4"	3"	382-0606	382-0626	382-0636
Equaling	4"	2"	382-0407	382-0427	382-0437
Equaling	5-1/2"	2-1/2"	382-0507	382-0527	382-0537
Equaling	6-1/4"	3"	382-0607	382-0627	382-0637
Barrette	4"	2"	382-0408	382-0428	382-0438
Barrette	5-1/2"	2-1/2"	382-0508	382-0528	382-0538
Barrette	6-1/4"	3"	382-0608	382-0628	382-0638
Crossing	4"	2"	382-0409	382-0429	382-0439
Crossing	5-1/2"	2-1/2"	382-0509	382-0529	382-0539
Crossing	6-1/4"	3"	382-0609	382-0629	382-0639
Joint	4"	2"	382-0410	382-0420	382-0430
Joint	5-1/2"	2-1/2"	382-0510	382-0520	382-0530
Joint	6-1/4"	3"	382-0610	382-0620	382-0630
Marking	4"	2"	382-1411	382-1421	382-1431
Marking	5-1/2"	2-1/2"	382-1511	382-1521	382-1531
Marking	6-1/4"	3"	382-1611	382-1621	382-1631
Slitting	4"	2"	382-1412	382-1422	382-1432
Slitting	5-1/2"	2-1/2"	382-1512	382-1522	382-1532
Slitting	6-1/4"	3"	382-1612	382-1622	382-1632

NEEDLE FILE SETS



12 Piece

Include one each of the same size of the above styles.

Size	Cut No. 0 Model No.	Cut No. 2 Model No.	Cut No. 3 Model No.
4"	382-0040	382-0042	382-0043
5-1/2"	382-0050	382-0052	382-0053
6-1/4"	382-0060	382-0062	382-0063
7"	382-0064	382-0065	382-0066

5 Piece

7" 2-CUT

Model No. 382-0071

6 Piece

Size	Cut No. 0 Model No.	Cut No. 2 Model No.	Cut No. 3 Model No.
4"	382-0640	382-0642	382-0643
5-1/2"	382-0650	382-0652	382-0653
6-1/4"	382-0660	382-0662	382-0663

10 Piece

Size	Cut No. 0 Model No.	Cut No. 2 Model No.	Cut No. 3 Model No.
4"	382-0140	382-0142	382-0143
5-1/2"	382-0150	382-0152	382-0153
6-1/4"	382-0160	382-0162	382-0163

10 Piece Set

7" 2-CUT

Model No. 382-0072

DIAMOND NEEDLE FILE SETS

Can be used on carbide, hardened steel, and ceramics, made with a hard chrome bond that gives a long life and wears extremely well.

5 Piece

Set include one each of:

Round, Half Round, Square, Equaling, Triangle

Approx. Length	Coarse Width	Medium	Fine
		Model No.	Model No.
7-1/4"	2"	382-0707	382-0708
5-3/4"	2-3/4"	382-0711	382-0715
5-3/4"	1-5/8"	382-0701	382-0705

10 Piece

Sets include one each of:

Round, Half Round, Square, Three Square, Flat, Crossing, Equaling, Barrette, Marking, Slitting.

Medium Type

OAL	Length of Cut	Model No.
5-1/2"	2-3/4"	382-0724
6-1/4"	3"	382-0725



Hand Tools

DIE MAKERS RIFFLER FILE SETS

Riffler Files are used by tool and die makers to clean odd and difficult places. A hobbyist's dream. Available in 6-3/4". No.0 and No. 2 Cut.



Cut	Model No.
No. 0	382-0032
No. 2	382-0034

8 PIECE DIE MAKER RIFFLER FILE SET EXTRA ROUGH CUT

Heavy Duty

8" Long, 3/16" Square Handle, 16 Different File Shapes. Complete With Plastic Pouch.

Model No. 382-0039



DIE SINKER RIFFLER FILE SETS

Double End No. 2 Cut
Complete with Plastic Wallet
5 Piece Model No. 382-0035
7" Heavy Duty Set 3/16" Body
5 Piece Model No. 382-0038
7" Set 1/8" Body



10 Piece Model No. 382-0041
6-1/2" Set 1/8" Body
10 Piece Model No. 382-0044
6-1/2" Heavy Duty Set 3/16" Body

GRINDING WHEEL DRESSER AND CUTTERS



- Hunting on type cutters will quickly remove the load form grinding wheels and present a new and face grinding surface.
- Fulfill most general dressing needs where fast dressing is the primary requirement.

No.	Size	For (Dia)	Dresser with one cutter Model No.	Replacement Cutters Model No.
#0		UP to 10"	287-6300	287-6350
#1		10"to 16"	287-6301	287-6351
#2		16"to 26"	287-6302	287-6352

DIAMOND MOUNTED POINT



Piece	Shank Size	Overall Length	Model No.
10pcs	3/32"	1-3/4"	389-9100
20pcs	3/32"	1-3/4"	389-9200
25pcs	3/32"	1-3/4"	389-9250
10pcs	1/8"	1-3/4"	389-9101
20pcs	1/8"	1-3/4"	389-9201
25pcs	1/8"	1-3/4"	389-9251
30pcs	1/8"	1-3/4"	389-9300
10pcs	1/4"	2-3/8"	389-9102
20pcs	1/4"	2-3/8"	389-9202

Pieces/set	Shank Size	Overall Length	Model No.
20pcs/set	3mm	45mm	389-9204
25pcs/set	3mm	45mm	389-9254
30pcs/set	3mm	45mm	389-9304
10pcs/set	6mm	45mm	389-9104
10pcs/set	6mm	60mm	389-9106
20pcs/set	6mm	60mm	389-9206

SHARPENING STONES

Coarse and fine grit vitrified into one stone. 120 & 150 grit.

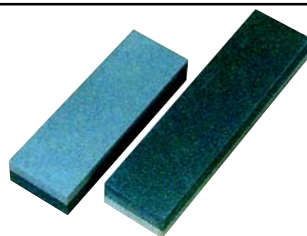

Size	Aluminum Oxide Model No.	Silicon Carbide Model No.
1 x 2 x 6"	399-6790	399-6792
1 x 2 x 8"	399-6791	399-6793

SCREW EXTRACTOR

Spiral Flute



For removing broken screws, bolts, studs, and pipes

Remove Screws	Use Drill Size	Carbon Steel Model No.	Alloy Steel Model No.
1# 3/32-- 5/32"	5/64"	312-8901	312-8921
2# 5/32-- 7/32"	7/64"	312-8902	312-8922
3# 7/32-- 9/32"	5/32"	312-8903	312-8923
4# 9/32-- 3/8" & 1/8" pipe	1/4"	312-8904	312-8924
5# 3/8-- 5/8" & 1/4" pipe	19/64"	312-8905	312-8925
6# 5/8-- 7/8" & 3/8" pipe	13/32"	312-8906	312-8926
7# 7/8-- 1-1/8" & 1/2" pipe	17/32"	312-8907	312-8927
8# 1-1/8-- 1-3/8" & 3/4" pipe	13/16"	312-8908	312-8928
9# 1-3/8-- 2" & 1" pipe	1-1/16"	312-8909	312-8929
10# 2-1/8-- 2-1/2" & 1-1/4" pipe		312-8910	312-8930
11# 2-1/2-- 3" & 1-1/2" pipe		312-8911	312-8931
5pcs/set in Plastic case #1-5.		312-8900	312-8920

Hand Tools



**ADJUSTABLE WRENCH,
JAPANESE TYPE, CR-V STEEL,
NEON-FINISHED
INCH/METRIC SCALE (WB-02)**



Size	Model No.
4"/100mm	800-0004
6"/150mm	800-0006
8"/200mm	800-0008
10"/250mm	800-0010
12"/300mm	800-0012
15"/375mm	800-0015
18"/450mm	800-0018
24"/600mm	800-0024

**ADJUSTABLE WRENCH,
JAPANESE-EUROPEAN,
CR-V STEEL, STAIN-FINISHED
WITH LASER MARKING (WB-02A)**



Size	Model No.
4"/100mm	800-0104
6"/150mm	800-0106
8"/200mm	800-0108
10"/250mm	800-0110
12"/300mm	800-0112
15"/375mm	800-0115
18"/450mm	800-0118

**ADJUSTABLE WRENCH,
CARBON STEEL, CHROMED
SEMI-POLISHED (WB-10)**



Size	Model No.
6"/150mm	800-0083
8"/200mm	800-0084
10"/250mm	800-0085
12"/300mm	800-0086
15"/375mm	800-0087
18"/450mm	800-0088
24"/600mm	800-0089

**HEAVY DUTY MALLEABLE-CAST-IRON PIPE
WRENCH WITH PHOSPHATED JAW (WG1)**



Size	Model No.
6"/150mm	800-1006
8"/200mm	800-1008
10"/250mm	800-1010
12"/300mm	800-1012
14"/350mm	800-1014
18"/450mm	800-1018
24"/600mm	800-1024
36"/900mm	800-1036
48"/1200mm	800-1048

**SUPER HEAVY DUTY MALLEABLE-CAST-IRON
PIPE WRENCH WITH PHOSPHATED JAW (WG2)**



Size	Model No.
6"/150mm	800-1106
8"/200mm	800-1108
10"/250mm	800-1110
12"/300mm	800-1112
14"/350mm	800-1114
18"/450mm	800-1118
24"/600mm	800-1124
36"/900mm	800-1136
48"/1200mm	800-1148

**ALUMINUM HEAVY DUTY PIPE WRENCH
WITH PHOSPHATED JAW (WG4)**



Size	Model No.
8"/200mm	800-1208
10"/250mm	800-1210
12"/300mm	800-1212
14"/350mm	800-1214
18"/450mm	800-1218
24"/600mm	800-1224
36"/900mm	800-1236

**ALUMINUM OFFSET TYPE PIPE WRENCH
WITH PHOSPHATED JAW (WG7)**

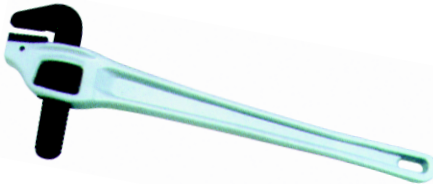

Size	Model No.
14"/350mm	800-1314
18"/450mm	800-1318
24"/600mm	800-1324

**HEAVY DUTY DUCTILE-CAST-IRON PIPE
WRENCH WITH PHOSPHATED JAW (WG5)**



Size	Model No.
6"/150mm	800-1406
8"/200mm	800-1408
10"/250mm	800-1410
12"/300mm	800-1412
14"/350mm	800-1414
18"/450mm	800-1418
24"/600mm	800-1424
36"/900mm	800-1436
48"/1200	800-1448

**AMERICAN TYPE LOCKING PLIER, CURVED-
JAW WITH WIRE CUTTER, NICKL-PLATED,
CR-V STEEL, (DL-V1)**



Size	Model No.
5"/100mm	800-3005
7"/175mm	800-3007
10"/250mm	800-3010
12"/300mm	800-3012

**JAPAN-TYPE LOCKING PLIER, LONG-NOSE-
JAW WITH WIRE CUTTER, NICKL-PLATED,
CR-V STEEL, (DL-IV)**

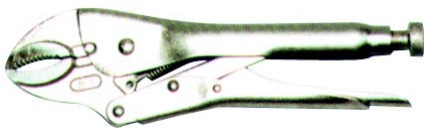

Size	Model No.
5"/100mm	800-3105
7"/175mm	800-3107
10"/250mm	800-3110

**JAPAN/AMERICAN-TYPE. LOCKING PLIER,
LONG-NOSE-JAW WITH WIRE CUTTER,
NICKL-PLATED (DL-III/II)**

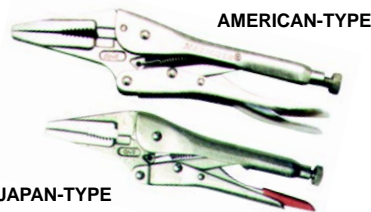

Size	Japan Type	American Type
6.5"/165mm	800-3165	800-3065
9"/225mm	800-3190	800-3090

**LOCKING SHEET METAL PLIERS NICKL-
PLATED (DLY-II)**



Size	Model No.
8"/200mm	800-3208

WWW.PRECOTOOLS.CN

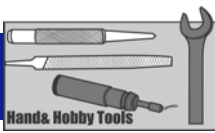

Hand Tools

"U" JAW TYPE WELDING CLAMP, NICKL-PLATED



Size	Model No.
9"/225mm	800-3309
10"/250mm	800-3310
11"/275mm	800-3311

LOCKING CLAMP PLIERS, NICKLE-PLATED (DL-CS)



Size	Model No.
11"/275mm	800-3411

SWEDISH PIPE WRENCH 90° CR-V STEEL WITH VPA GS APPROVAL, (WY-01)



Size	Model No.
1"/25mm	800-1510
1.5"/38mm	800-1515
2"/50mm	800-1520
3"/75mm	800-1530

SWEDISH PIPE WRENCH 45° CR-V STEEL, STRAIGHTH JAW WITH VPA GS APPROVAL (WY-09)



Size	Model No.
0.5"/12mm	800-1605
1"/25mm	800-1610
1.5"/38mm	800-1615
2"/50mm	800-1620
3"/75mm	800-1630

SWEDISH PIPE WRENCH 45° CR-V STEEL, BEND-JAW WITH VPA GS APPROVAL, (WY-04)



Size	Model No.
0.5"/12mm	800-1705
1"/25mm	800-1710
1.5"/38mm	800-1715
2"/50mm	800-1720
3"/75mm	800-1730

SWEDISH PIPE WRENCHS, CR-V STEEL, BEND-JAW WITH VPA GS APPROVAL, (WY-03)



Size	Model No.
0.5"/12mm	800-1805
1"/25mm	800-1810
1.5"/38mm	800-1815
2"/50mm	800-1820
3"/75mm	800-1830

BOLT CUTTER, ADJUSTABLE HEAVY DUTY BLADE, (WD-06)



Size	Phosphated Blade	Satin Finished Blade
12"/300mm	800-8012	800-8112
14"/350mm	800-8014	800-8114
18"/450mm	800-8018	800-8118
24"/600mm	800-8024	800-8124
30"/750mm	800-8030	800-8130
36"/900mm	800-8036	800-8136
42"/1050mm	800-8042	800-8142

BOX JOINT PLIERS, POWER-PAINTED (WS-1A)



Size	Traditional Model	New Model
10"/250mm	800-2010	800-2110
12"/300mm	800-2012	800-2112

TOWER PINCER, PHOSPHATED DIPPED HANDLE OR NEON FINISHED (WH-1)

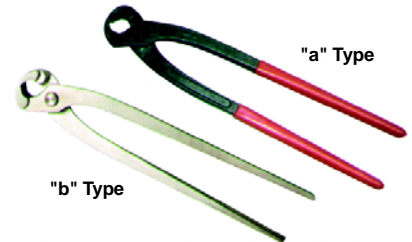

Size	Phosphated with Dipped Handle	
	"a" Type	Neon Finished "b" Type
9"/225mm	800-6009	800-6109
10"/250mm	800-6010	800-6110

RATCHET WRENCH, QUICK RELEASE, 72 TEETH, ROUND HANDLE (WT-01B)



Size	Model
1/4"	800-5105
3/8"	800-5110
1/2"	800-5115

RATCHET WRENCH, QUICK RELEASE, 72 TEETH, CURVED-H-HANDLE (WT-03)



Size	Model
1/4"	800-5005
3/8"	800-5010
1/2"	800-5015

AMERICAN TYPE, RATCHET WRENCH, QUICK RELEASE, ROUND HANDLE (WT-04)

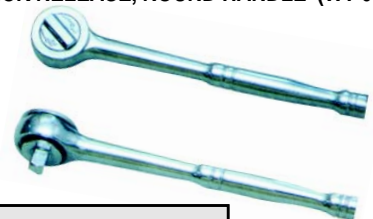

Size	Model No.
1/4"	800-5205
3/8"	800-5210
1/2"	800-5215

WWW.PRECOTOOLS.CN



HEX KEY, CR-V STEEL FULLY HARDENED (NB-01)

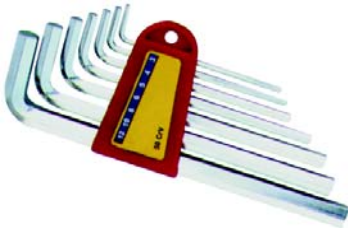

Description	Model No.
7pcs/set, 3-4-5-6-8-10-12mm, Long Type, Chrome-Plated	800-4000
7pcs/set, 3-4-5-6-8-10-12mm, Long Type, Black-Finished	800-4001

HEX KEY-BALL POINT, CR-V STEEL BLACK FINISHED, FULL. HARDENED (NB-II)

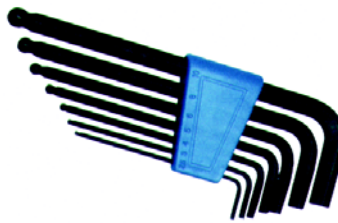

Description	Model No.
7pcs/ser, 2.5-3-4-5-6-8-10mm, Extra Long, CR-V Black-finished	800-4100

FORGED STEEL CHISEL, BLACK-FINISHED, HIGH-FREQUENCY-QUENCHED (WZ-01)



Size	Model No.
6.4"/160mm	800-7006
8"/200mm	800-7008
10"/250mm	800-7010

COMBINATION WRENCHES CHROME PLATED

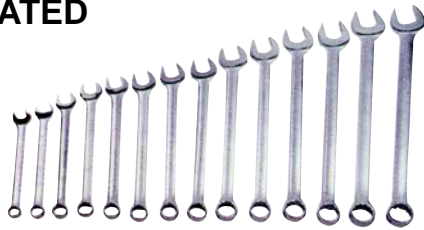

Metric

Size	Carbon steel Model No.	CR-V steel Model No.
8mm	800-0408	800-0508
9mm	800-0409	800-0509
10mm	800-0410	800-0510
11mm	800-0411	800-0511
12mm	800-0412	800-0512
13mm	800-0413	800-0513
14mm	800-0414	800-0514
15mm	800-0415	800-0515
16mm	800-0416	800-0516
17mm	800-0417	800-0517
18mm	800-0418	800-0518
19mm	800-0419	800-0519

Inch

Size	Carbon steel Model No.	CR-V steel Model No.
1/4"	800-0604	800-0704
5/16"	800-0605	800-0705
3/8"	800-0606	800-0706
7/16"	800-0607	800-0707
1/2"	800-0608	800-0708
9/16"	800-0609	800-0709
5/8"	800-0610	800-0710
11/16"	800-0611	800-0711
3/4"	800-0612	800-0712
13/16"	800-0613	800-0713
7/8"	800-0614	800-0714

1/4" DR.6PT.SOCKET, CR-V STEEL



Metric

Size	Model No.
4.0mm	802-0040
4.5mm	802-0045
5.0mm	802-0050
5.5mm	802-0055
6.0mm	802-0060
7.0mm	802-0070
8.0mm	802-0080
9.0mm	802-0090
10.0mm	802-0100
11.0mm	802-0110
12.0mm	802-0120
13.0mm	802-0130
14.0mm	802-0140

Inch

Size	Model No.
5/32"	802-1005
3/16"	802-1006
7/32"	802-1007
1/4"	802-1008
9/32"	802-1009
5/16"	802-1010
11/32"	802-1011
3/8"	802-1012
7/16"	802-1014
1/2"	802-1016

1/2" DR.6PT.SOCKET, CR-V STEEL



Metric

Size	Model No.
10mm	802-5010
11mm	802-5011
12mm	802-5012
13mm	802-5013
14mm	802-5014
15mm	802-5015
16mm	802-5016
17mm	802-5017
18mm	802-5018
19mm	802-5019
20mm	802-5020
21mm	802-5021
22mm	802-5022
23mm	802-5023
24mm	802-5024
27mm	802-5027
30mm	802-5030
32mm	802-5032

Inch

Size	Model No.
5/16"	802-6010
3/8"	802-6012
7/16"	802-6014
1/2"	802-6016
9/16"	802-6018
5/8"	802-6020
11/16"	802-6022
3/4"	802-6024
13/16"	802-6026
7/8"	802-6028
15/16"	802-6030
1"	802-6032
1-1/16"	802-6034
1-1/8"	802-6036
1-1/4"	802-6038

3/8" DR.6PT.SOCKET, CR-V STEEL



Metric

Size	Model No.
7.0mm	802-3070
8.0mm	802-3080
9.0mm	802-3090
10.0mm	802-3100
11.0mm	802-3110
12.0mm	802-3120
13.0mm	802-3130
14.0mm	802-3140
15.0mm	802-3150
16.0mm	802-3160
17.0mm	802-3170
18.0mm	802-3180
19.0mm	802-3190
20.0mm	802-3200
21.0mm	802-3210
22.0mm	802-3220

Inch

Size	Model No.
1/4"	802-4008
5/16"	802-4010
3/8"	802-4012
7/16"	802-4014
1/2"	802-4016
9/16"	802-4018
5/8"	802-4020
11/16"	802-4022
3/4"	802-4024
13/16"	802-4026
7/8"	802-4028



Hand Tools



16 PCS TOOL SET
Model No.802-0016

TOOL SET

- PACKED IN PLASTIC-BOX
- INCLUDING:
- 1pc 8" Adjustable Wrench with PVC Handle
- 1pc 8" Pipe Wrench
- 1pc 7" Linesman's Pliers
- 1pc 80Z Claw Hammer
- 1pc Electrician Utility Knife
- 1pc 2-Metre Tape Measure
- 1pc Scissors
- 1pc Digital Voltage Probe
- 1pc 6" Long Nose Pliers
- 1pc Bottle Opener
- 1pc 6" Chisel
- 1pc 160mm Tweezers
- 2pcs Phillips Screwdriver 3minx75mm, 6mmx100mm
- 2pcs Slotted Screwdriver 3mmx75mm, 6mmx100mm

WRENCH & SOCKET SET, CR-V STEEL

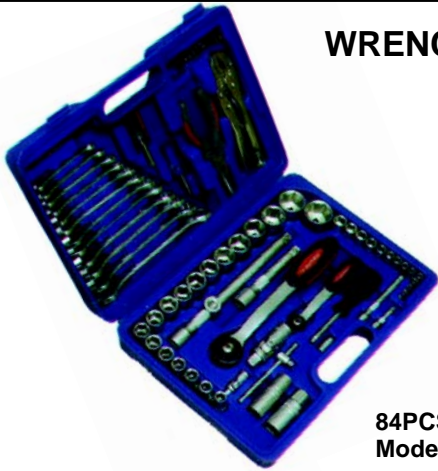

84PCS/SET
Model No.802-7020

- PACKED IN PLASTIC-BOX
- INCLUDING:
- 13pcs 1/4" 6PT sockets 4-14mm
- 18pcs 1/2" 6PT socket 10-32mm
- each of 1/4" & 1/2" WT03 ratchet handle
- 1/4" extension bar 2" & 4" of each
- 1/2" extension bar 5"
- each of 1/4" & 1/2" sliding T-bar
- each of 1/4" & 1/2" universal joint
- 1/2" spark plug socket 16 & 21mm of each
- 12pcs comb-wrench 8-19mm
- 1/4" Dr. spinner handle & bit adaptor
- 1/4" Dr. 25mm hex bit (2-2.5-3-4-5mm)
- slotted bit (3-4-4.5-5)
- torx bit (T10-T15-T20-T25)
- phillips bit (PH0-PH3)
- pozidrive bit (PZ0-PZ3)
- slotted screwdriver 6x38mm
- phillips screwdriver 6x38mm
- 6" long nose plier & 7" locking plier

87PCS/SET Model No.802-7025



- PACKED IN PLASTIC-BOX
- INCLUDING:
- 13pcs 1/4" 6PT sockets 4-14mm
- 18pcs 1/2" 6PT socket 10-32mm
- each of 1/4" & 1/2" WT03 ratchet handle
- 1/4" extension bar 2" & 4" of each
- 1/2" extension bar 5"
- each of 1/4" & 1/2" sliding T-bar
- each of 1/4" & 1/2" universal joint
- 1/2" spark plug socket 16 & 21mm of each
- 11pcs comb-wrench 8-19 except 16mm
- 1/4" Dr. spinner handle & bit adaptor
- 1/4" Dr. 25mm hex bit (2-2.5-3-4-5mm)
- slotted bit (3-4-4.5-5)
- torx bit (T10-T15-T20-T25)
- phillips bit (PH0-PH3)
- pozidrive bit (PZ0-PZ3)
- square bit (S1-S3)
- slotted screwdriver 6x38mm
- phillips screwdriver 6x38mm
- 6.5" long nose locking plier w/bi-color grips
- 7pcs hex keys (2.5-3-4-5-6-8-10)

32PCS. 1/2" DR. SOCKET WRENCH SET Model No.802-7032



- PACKED IN PLASTIC-BOX
- INCLUDING:
- 23pcs 6pt. Metric Sockets** 8,9, 10,11,12,13,14,15,16,17,18,19,19, 20,21,22,23,24,26,27,28,30,32mm
- 1pc Screwdrive** 52mm
- 8pcs Accessories** Ratchet t handle
Flex Handle 10"
Speed Handle
Sliding T-bar
Universal Joint
Extension Bars 5" & 10"
Tommy bar 10"

WWW.PRECOTOOLS.CN



**44Pcs. 1/4" & 1/2" DR.SOCKET WRENCH SET
Model No.802-7044**

- PACKED IN PLASTIC-BOX
- INCLUDING:

13pcs 1/4" Dr.6pt.Metric Sockets	4,4.5,5.5,5.6,7,8,9,10,11,12,13,14mm
18pcs 1/2" Dr.6pt.Metric Sockets	6,7,8,9,10,11,12,13,14,15,16,17,18,19,20,21,22,23,24,27,30,32mm
2pcs 1/2" Dr.Spark Plug Sockets	16,21mm
11pcs Acoemories	1/4", 1/2" Dr.Quick Relearn Ratchet Handle
	1/4" Dr.Sliding T-bar
	1/4", 1/2" Dr.Oniversal Joint
	1/4" Dr. Extension Bars 2" &4"
	1/2" Dr. Extension Bars 5" &10"
	3/8" Fx1/2" M 3-Way Adapter
	1/4" Dr.Spinner Handle



**94PCS 1/4" & 1/2" DR.SOCKET WRENCH SET
Model No.802-7094**

- PACKED IN PLASTIC-BOX
- INCLUDING:

13pcs 1/4" Dr.6pt.Metric Sockets	4,4.5,5.5,5.6,7,8,9,10,11,12,13,14mm
8pcs 1/4" Dr . Metric Deep Sockets	6,7,8,9,10,11,12,13mm
18pcs 1/2"Dr.6pt.Metric Sockets	10,11,12,13,14,15,16,17,18,19,20,21,22,23,24,27,30,32mm
4pcs 1/2"Dr.Metric Deep Sockets	14, 15, 17,19mm
2pcs 1/2" Dr.Spark Plug Sockets	16,21mm
17pcs 1/4" Dr.Bit Sockets	Phillips #1,#2 Slotted 4,5,5,7mm Pozidriv # 1, #2 Hex 3,4,5,6mm Torx T8,T10,T15,T20,T25,T30
15pcs 8mm Shank 30LBits	Phillips #3, #4 Slotted 8, 10, 12mm Pozidriv #3,#4 Torx T40,T45,T50,T55 Hex 8,10, 12, 14mm
3pcs Hex Keys	1.5,2,2.5mm
14pcs Accessories	1/4", 1/2" Dr.Quick Release Ratchet Handle 1/4" Dr.Sliding T-bar 1/4", 1/2" Dr. Universal Joint 1/4" Dr. Extension Bars2" &4" 1/2" Dr. Extension Bars 5" &10" 3/8" Fx1/2" M 3-Way Adapter 1/4" Dr. Flexible Extension Bar6" 1/4" Dr. Spinner Handle 1/2" Dr. Bit Adapter Adptor1/4" HexX1/4" S



**22pcs/set
Model No.802-7005**

- PACKED IN METAL-BOX
- INCLUDING:
 - 15pcs 3/8" 6PT sockets 6-19 by 1mm & 22mm
 - 3/8" extension bar 3" & 6" of each
 - 3/8" spark plug socket 16& 21mm of each
 - 3/8" universal joint
 - 3/8" sliding T-bar
 - 3/8" WT03 ratchet handle

**26pcs/set
Model No.802-7010**

- PACKED IN METAL-BOX
- INCLUDING:
 - 18pcs 1/2" 6PT sockets 10-32mm
 - 1/2" extension bar 3" 5" 10" of each
 - 1/2" spark plug socket 16 & 21mm of each
 - 1/2" universal joint
 - 1/2" sliding T-bar 10"
 - 1/2" WT03 ratchet handle

**27pcs/set
Model No.802-7015**

- PACKED IN METAL-BOX
- INCLUDING:
 - 18pcs 1/2" 6PT sockets 10-32mm
 - 1/2" extension bar 3" 5" 10" of each
 - 1/2" spark plug socket 16 & 21mm of each
 - 1/2" universal joint
 - 1/2" flexible bar
 - 1/2" WT03 ratchet handle

DOWELING JIG

This tool is an attachment for wood working machine. It is well designed for drilling, it could be adjusted height based on the height of work piece.



Model No. 830-4000

QUICK CLAMP

- Fits all milling machine vises with 3/8"-3/4" vise jaws.
- Hardened steel body. 1" wide and two steel guide pins for positive clamping.
- Clamps quickly and easily to the top of hard or soft jaws.

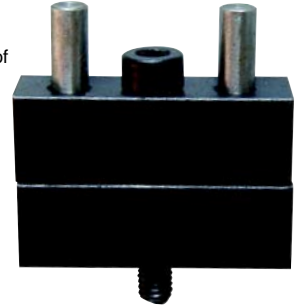

Model No. 209-9006

MAGNETIC ADJUSTABLE LINK

- For welding and holding steel plates.
- Two heavy duty. Magnets 2" long & 1" square.
- Easy angle adjustment using 2 bars with wing nuts.

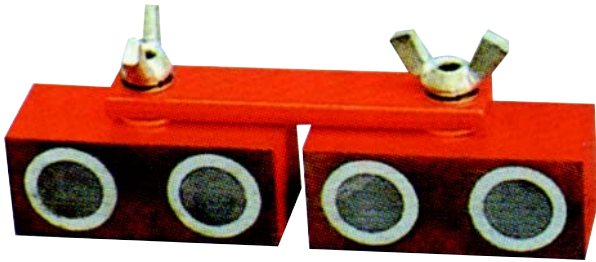

Model No. 625-0115

MAGNETIZER / DEMAGNETIZER

- Ideal for magnetizing/demagnetizing tools and small steel parts, and your own tools on the job.
- Powerful permanent magnet for extended life.



Model No. 625-0000

DRIFT KEYS-DROP FORGED

- Removes taper shank drills or readers
- From sleeves or sockets quickly

Set Model No. 292-6240

Set include all FOUR size



Body	Fits Mt. Sleeves Overall and sockets		ThickNess	Width at Hole	Model No.
	Length	Length			
1	No.1 M.T.	4-1/2"	13/64"	11/16"	292-6220
2	No.2 M.T.	4-1/8"	1/4"	13/16"	292-6225
3	No.3 M.T.	6-3/4"	5/16"	1-1/16"	292-6230
4	No.4.5.6 M.T.	7-1/8"	15/32"	1-1/8"	292-6235

SNAP LEVER SIGHT FEED OILER

- Clear acrylic lenses.off/on lever on top of oiler.
- Made of non-rust brass.
- Adjustable knurled feed knob below top switch.



Body	Shank	Die dia.	Model No.
3-9/64"	1"	1/8"	251-1001
3-9/64"	1"	1/4"	251-1002
3-3/4"	1-1/4"	1/8"	251-1003
3-3/4"	1-1/4"	1/4"	251-1004
3-5/16"	1-1/2"	1/8"	251-1005
3-5/16"	1-1/2"	1/4"	251-1006
4-23/32"	2"	1/4"	251-1007
5-5/16"	2-1/2"	1/4"	251-1008
5-29/32"	3"	1/4"	251-1009



QUILL STOP

Set Model No. 209-9003

For Bridge Port Type Mills

Features:

- Quick action clip.
- Clips on quill easily for rapid depth setting.
- Top or bottom positioning.
- 0.020" fine adjustable.
- Easily installed, quickly moved.

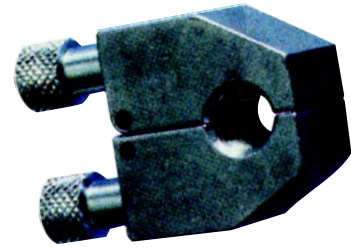

QUICK INDEXING QUILL FEED HANDLE

Eliminates removing quill fees resetting or repositioning. Quick flick of the wrist retracts index plate pin of quill allowing you to move the handle into any position. Spring loaded pin activates quill feed. Speeds up all operations. Heavy duty, will not bend or break.

Model No. 209-9002

For Your Mill With 1" Die.Hub.

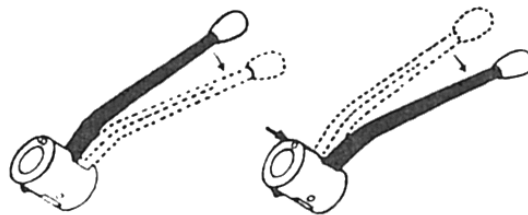
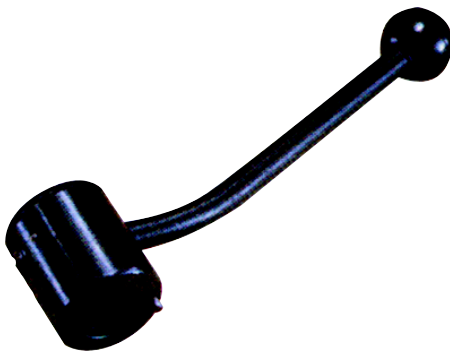

ILLUMINATED MAGNIFIER



Model No. 117-0050

- 3 diopter 5" lens
 - 45" extension arm
 - Round florescent fixture surrounds the magnifier.
- Spring loaded hinged arms support the light which can be Clamped to most work areas
- Ideal for the tool room or model marker

MAGNIFYING LAMP

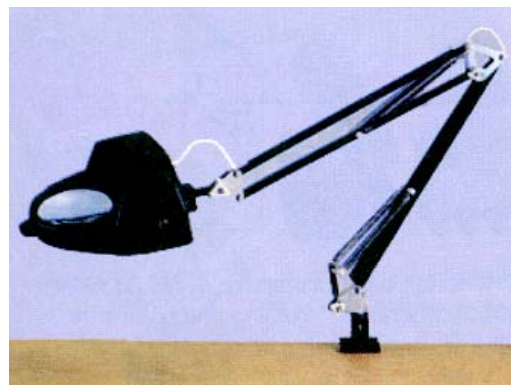

Model No. 117-0060

- 3 diopter 4" lens
- 60 watt bulb (not included)
- 39" extension arm
- Black enamel finish



Hand Tools

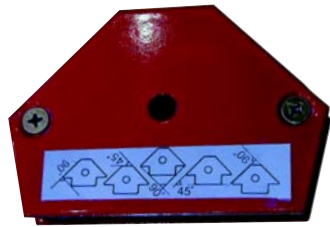

B Type



A Type



C Type

MAGNETIC QUICK CLAMP

30, 45, 60, 75, 90 degree angle

Min. Diameter of round workpiece is 13mm

Type	Max. Magnetic Power to		Size	Model No.
	Round workpiece	Flat workpiece		
A	40kg	70kg	110x110x16mm	625-0105
A	25kg	50kg	110x110x16mm	625-0100
B	18kg	45kg	85x51x13mm	625-0110
B	8kg	28kg	85x51x13mm	625-0107
C	40kg	70kg	95x110x16mm	625-0120
C	25kg	50kg	95x110x16mm	625-0117

90° MAGNETIC QUICK CLAMP

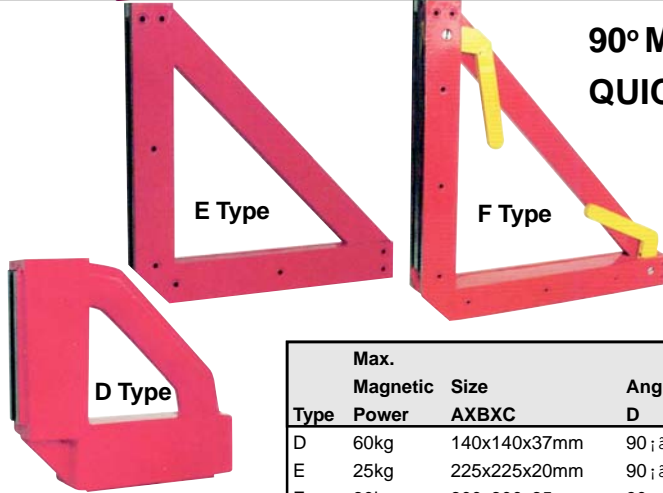
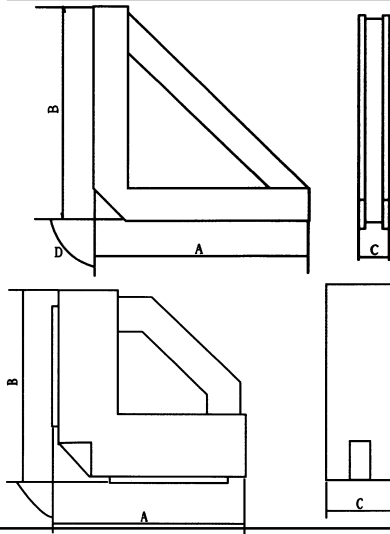

Type	Max. Magnetic Power	Size AXBXC	Angle		Weight	Model No.
			D	Weight		
D	60kg	140x140x37mm	90° ±	1.7kg		625-0150
E	25kg	225x225x20mm	90° ±	2kg		625-0153
F	30kg	300x300x35mm	90° ±	4.6kg		625-0155

PERMANENT MAGNETIC LIFTS

Designed for efficient, trouble free, low maintenance service.

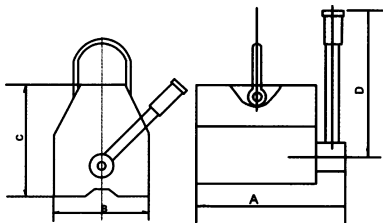

Round workpiece	Max. Magnetic Power to Flat workpiece	Size AXBXCXD	Weight	Model No.
110lbs/50kg	220lbs/100kg	5"x2-2/5"x2-3/5"x5-1/2" (125x62x67x40mm)	6.2lbs/2.8kg	625-0210
220lbs/100kg	440lbs/200kg	6"x3-3/5"x3-3/5"x6-7/10" (152x91x91x170mm)	15.4lbs/7kg	625-0220
330lbs/150kg	660lbs/300kg	8"x3-3/5"x3-3/5"x6-7/10" (195x91x91x170mm)	22lbs/10kg	625-0230



HEAVY DUTY PERMANENT MAGNETIC LIFTS

Magnetic Power: 400kg,
Length: 205mm
Width: 135mm
Height: 180mm
Weight: 43kg

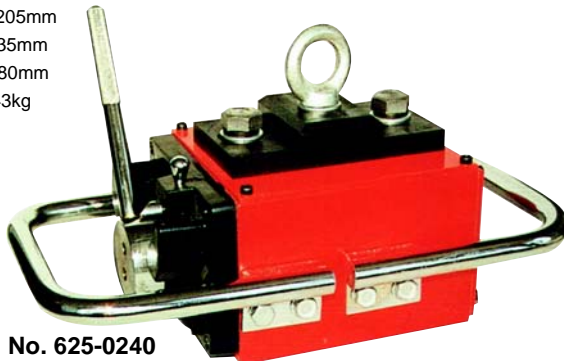

Model No. 625-0240

HAND USE MAGNETIC LIFTS

Magnetic Power: 50kg,
Length A : 120mm
Width B : 100mm
Height C : 270mm
Weight: 3kg

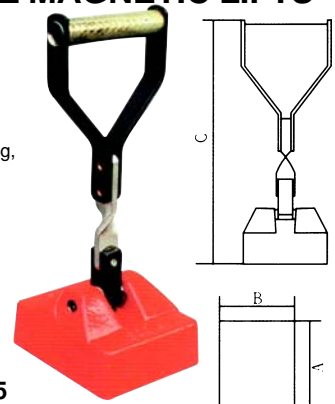

Model No. 625-0005